



Enviro-Equipment Inc.
10120 Industrial Drive
Pineville NC 28134

Stock#: 255

Status: In stock

Dimensions: 21"x21"x19"

Weight: 221 lbs

Description: Blower

MFG- Roots

Model- 59U-RAI

Serial- SR0014232

Port size- 4"





Enviro-Equipment Inc.
10120 Industrial Drive
Pineville NC 28134

PERFORMANCE BASED ON AIR,
INLET AT 68°F
DISCHARGE PRESSURE = 30" HG ABS.
DECEMBER 2004

VACUUM PERFORMANCE
FRAME 59 U-RA
MAX. VACUUM = 15" HG
MAX. SPEED = 2850 RPM

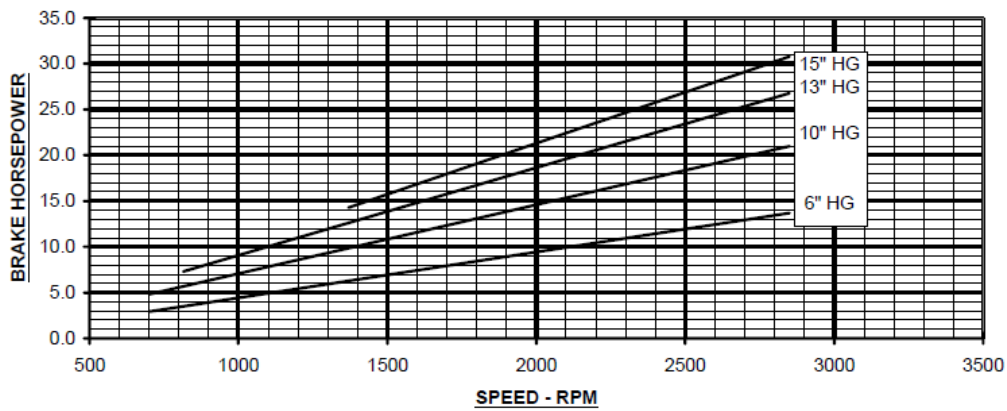
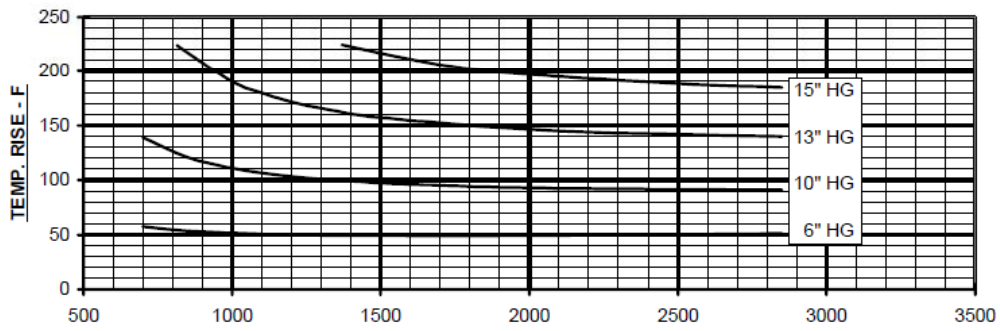
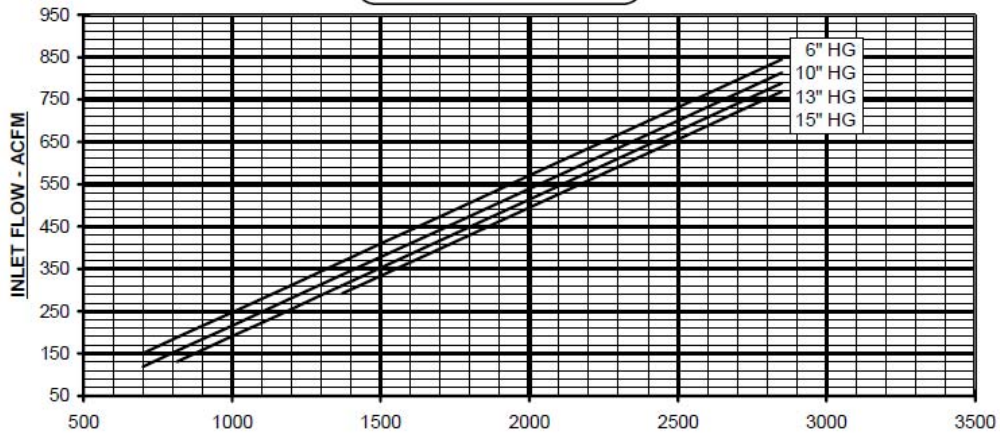



Enviro-Equipment Inc.
10120 Industrial Drive
Pineville NC 28134

PERFORMANCE BASED ON AIR,
INLET AT 14.7 PSIA & 68°F
DECEMBER 2004

PRESSURE PERFORMANCE
FRAME 59 U-RAI
MAX. PRESSURE RISE = 7.3 PSI
MAX. SPEED = 2850 RPM

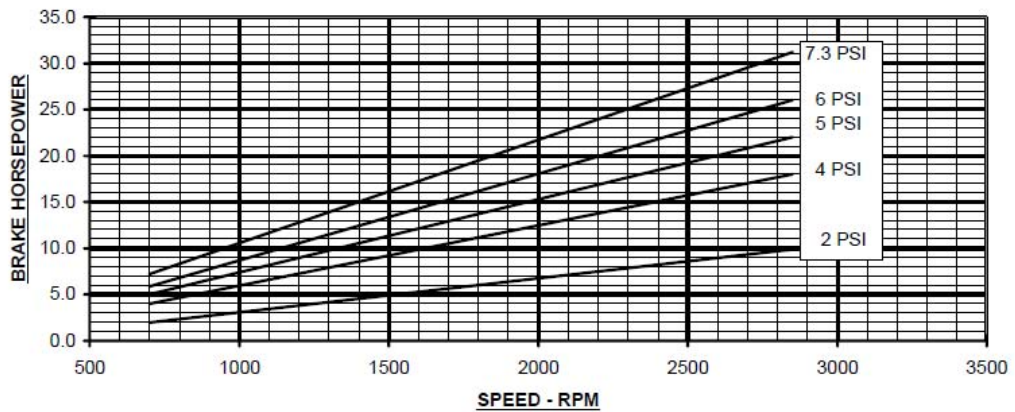
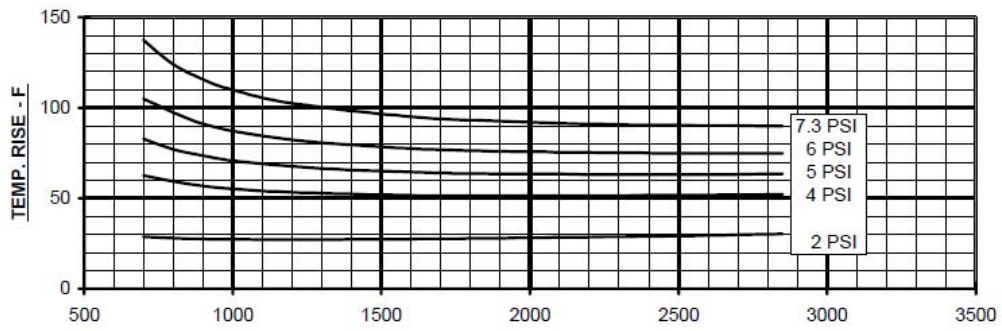
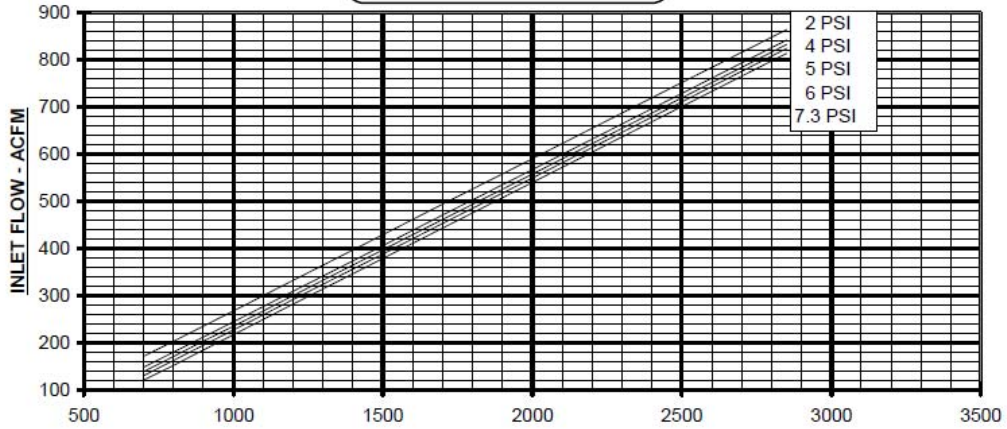

ROOTS™ UNIVERSAL RAI®

Rotary Positive Displacement Blowers

Specifications Frames 22 thru 718

DESIGN AND CONSTRUCTION FEATURES

- Steel detachable mounting feet
- Rigid one-piece cast iron casing
- Anti-friction bearings
- Thrust control
- Splash oil lubricated spur timing gears
- Connections in standard pipe sizes
- Balanced, precision machined bi-lobe impellers
- Ground steel shafts

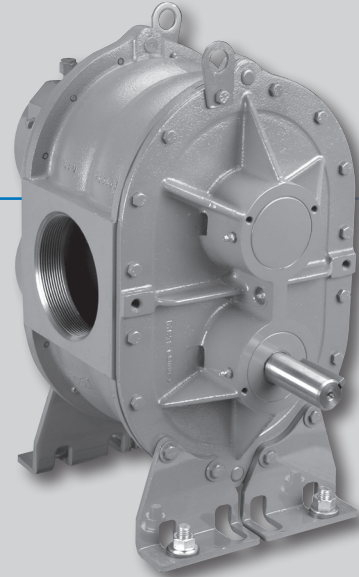

Basic Blower Description

Universal RAI blowers are heavy duty blowers designed with detachable rugged steel mounting feet that permit easy in-field adaptability to either vertical or horizontal installation requirements.

Because of the detachable mounting feet, these units can be easily adapted to any of four drive shaft positions - right hand, left hand, bottom or top. The compact, sturdy design is engineered for continuous service when operated in accordance with speed and pressure ratings.

The basic model consists of a cast iron casing and cast iron involute impellers. Carburized and ground alloy steel spur timing gears are secured to the steel shafts with a taper mounting and locknut. Oversized antifriction bearings are used, with a cylindrical roller bearing at the drive shaft to withstand V-belt pull. The Universal RAI features thrust control, with splash oil lube on the gear end and grease lube on the drive end.

Available accessories include driver, relief valve, inlet and discharge silencers, inlet filter, check valve, extended base, v-belt or flexible coupling and drive guards.

Strongest Warranty in the Industry

ROOTS™ Universal RAI® blowers are warranted for two years plus an additional 6 months for shipping and construction where required. ROOTS synthetic oil is recommended for longer lubricant life.



Vertical Gear End



Horizontal Gear End



Horizontal Drive End

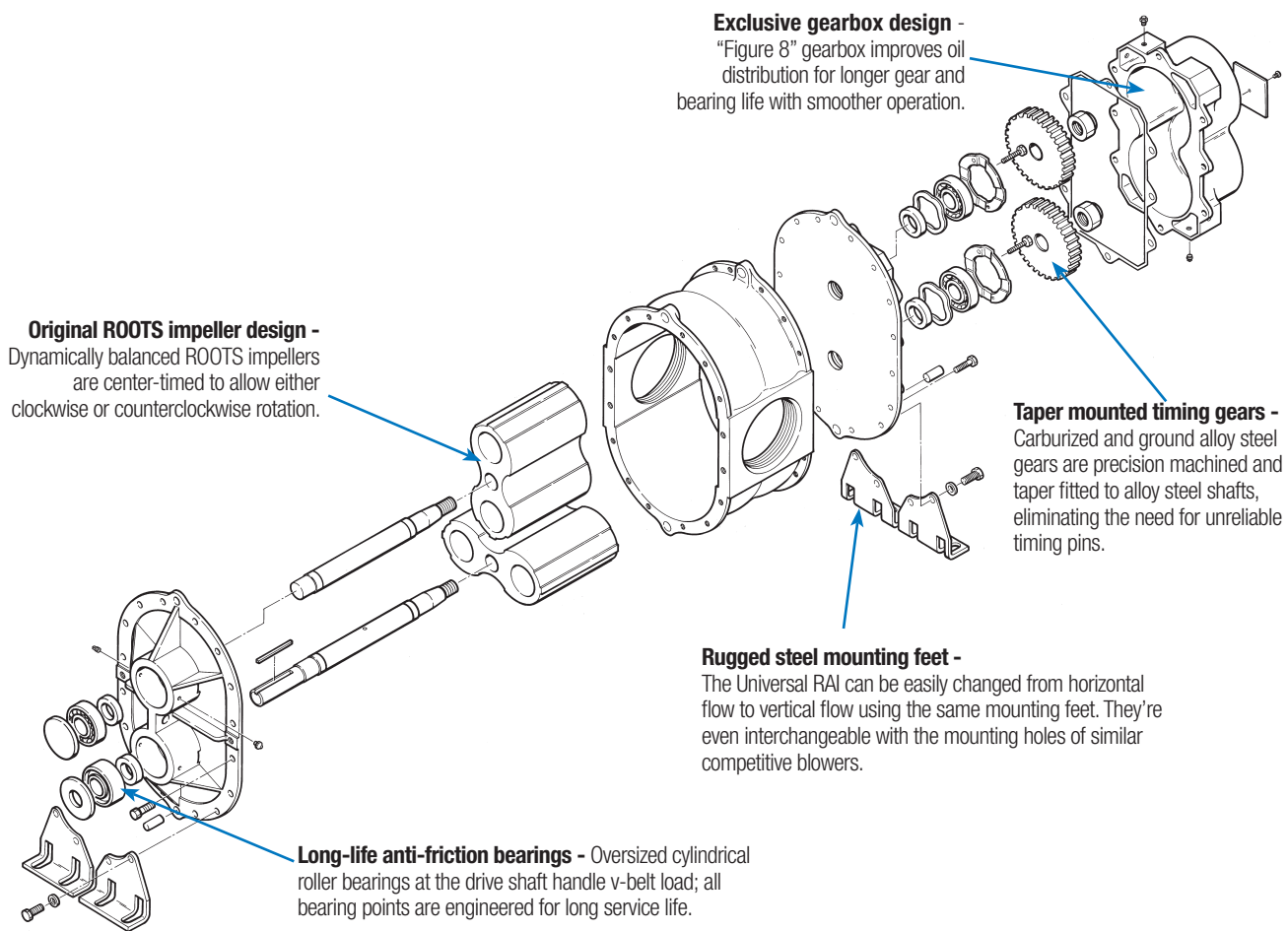

Versatile mounting - You can mount the Universal RAI in multiple positions to accommodate your specific needs. With your choice of 17 frame sizes, there's a URAI that fits right into your OEM or replacement application.

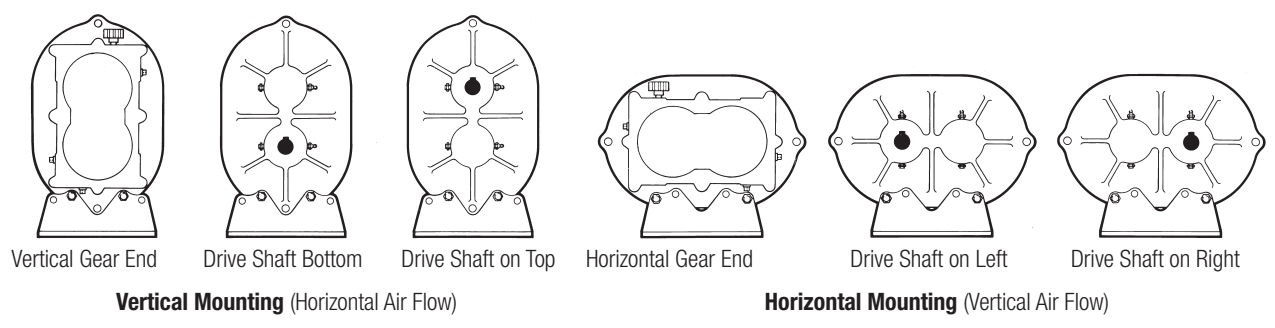

Bi-Lobe Operating Principle

Two figure-eight lobe impellers mounted on parallel shafts rotate in opposite directions. As each impeller passes the blower inlet, it traps a finite volume of air and carries it around the case to the blower outlet, where the air is discharged. With constant speed operation, the displaced volume is essentially the same regardless of pressure, temperature or barometric pressure. Timing gears control the relative position of the impellers to each other and maintain small but finite clearances. This allows operation without lubrication being required inside the lobe cavity.

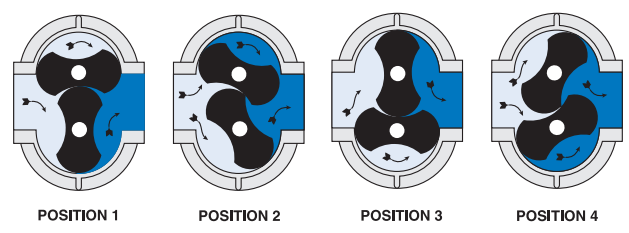

URAI Blower Performance

Frame Size	Speed RPM	1 PSI		6 PSI		7 PSI		10 PSI		12 PSI		13 PSI		14 PSI		15 PSI		Maximum Vacuum		
		CFM	BHP	CFM	BHP	CFM	BHP	CFM	BHP	CFM	BHP	CFM	BHP	CFM	BHP	CFM	BHP	"HG	CFM	BHP
22	1160	10	0.1															4	6	0.2
	3600	49	0.3	38	1.6	36	1.8	32	2.6	29	3.1							14	28	1.8
	5275	76	0.5	64	2.4	63	2.7	59	3.8	56	4.6							15	53	2.8
24	1160	24	0.2															6	12	0.5
	3600	102	0.6	83	3.1	81	3.6											14	69	3.5
	5275	156	0.9	137	4.6	135	5.4											15	119	5.5
32	1160	40	0.2	21	1.4	19	1.6											10	18	1.1
	2800	113	0.6	95	3.4	93	3.9	86	5.6	82	6.7	81	7.2	79	7.8	77	8.3	15	78	4.1
	3600	149	0.9	131	4.4	129	5.2	122	7.3	118	8.7	117	9.4	115	10.1	113	10.8	16	110	5.3
33	1160	55	0.3	31	1.9	28	2.2											10	27	1.5
	2800	156	0.9	132	4.6	129	5.4	120	7.7	116	9.2							14	113	5.2
	3600	205	1.2	181	6.1	178	7	170	9.9	165	11.9							15	159	7.3
36	1160	95	0.5	61	3.1	57	3.6											10	55	2.5
	2800	262	1.5	229	7.7	224	8.9											12	213	7.5
	3600	344	2.1	310	10.1	306	11.7											15	278	12.1
42	860	38	0.2	18	1.4	15	1.6											8	19	0.9
	1760	92	0.5	72	2.8	69	3.3	62	4.7	58	5.6							14	56	3.2
	3600	204	1.4	183	6.1	181	7.1	173	9.9	169	11.8	167	12.8	165	13.7	163	14.7	16	160	7.7
45	860	79	0.5	42	2.7	37	3.2											8	46	1.8
	1760	188	1	151	5.7	146	6.6	133	9.4									12	134	5.5
	3600	410	2.7	374	12.2	369	14.1	356	19.8									16	332	15.4
47	860	105	0.6	59	3.6	53	4.2											8	63	2.4
	1760	249	1.3	203	7.5	196	8.7											12	181	7.3
	3600	542	3.5	496	16.1	490	18.6											15	452	19.1
53	700	72	0.4	42	2.4	38	2.8											10	36	2
	1760	211	1.2	181	6.3	177	7.3	167	10.3	160	12.3	157	13.3	155	14.4			14	158	7.1
	2850	355	2.5	325	10.7	321	12.3	310	17.2	304	20.5	301	22.1	298	23.8	295	25.4	16	291	13.4
56	700	123	0.7	78	4.1	72	4.7											10	70	3.3
	1760	358	2	312	10.5	306	12.2	290	17.3	280	20.6	276	22.3					14	276	11.8
	2850	598	4	553	17.7	547	20.5	531	28.7	521	34.2	517	37					16	501	22.4
59	700	187	1	130	5.9													8	135	3.9
	1760	529	2.9	472	15.3	464	17.8											12	445	14.9
	2850	881	5.9	824	26	816	30											15	770	30.8
65	700	140	0.8	93	4.5	86	5.3	70	7.5									12	71	4.4
	1760	400	2.4	353	11.9	347	13.8	330	19.4	320	23.2	316	25.1	311	27	307	28.9	16	300	15.2
	2350	546	3.8	499	16.4	492	19	475	26.5	466	31.6	461	34.1	457	36.6	452	39.1	16	445	25.6
68	700	224	1.2	149	7.3	139	8.5											10	135	5.9
	1760	643	3.7	567	18.9	557	21.9	530	31	515	37	507	40.1	500	43.1			15	495	22.7
	2350	876	5.6	801	25.9	790	29.9	763	42.1	748	50.2	740	54.2	733	58.3			16	715	32.8
615	700	420	2.3	279	13.6	260	15.9											8	292	8.9
	1760	1205	6.6	1063	34.9	1044	40.6											12	997	33.9
	2350	1641	9.7	1500	47.6	1481	55.2											14	1389	53.4
76	575	192	1.1	134	6.1	126	7.1	105	10.2									12	117	6
	1400	527	3	468	15.4	460	17.8	439	25.3	427	30.2	421	32.7	415	35.1	410	37.6	16	413	19.7
	2050	790	5.3	731	23.4	723	27	702	37.9	690	45.1	684	48.7	679	52.4	673	56	16	674	29.5
711	575	362	1.9	271	11.1	258	13	226	18.6									12	228	10.9
	1400	970	5.2	880	27.7	867	32.2	835	45.7									15	793	33.5
	2050	1450	8.8	1359	41.8	1347	48.4	1315	68.2									16	1256	53.1
718	575	600	3.1	470	18.1													10	446	14.8
	1400	1590	8.1	1460	44.8													12	1398	43.6
	2050	2370	13.3	2240	66.9													12	2178	64.7

Notes: 1. Performance based on inlet air at standard pressure of 14.7 psia, standard temperature of 68° F, and specific gravity of 1.0.
2. Vacuum ratings based on inlet air at standard temperature of 68°F, discharge pressure of 30" Hg and specific gravity of 1.0.

Outline Drawing and Dimensions

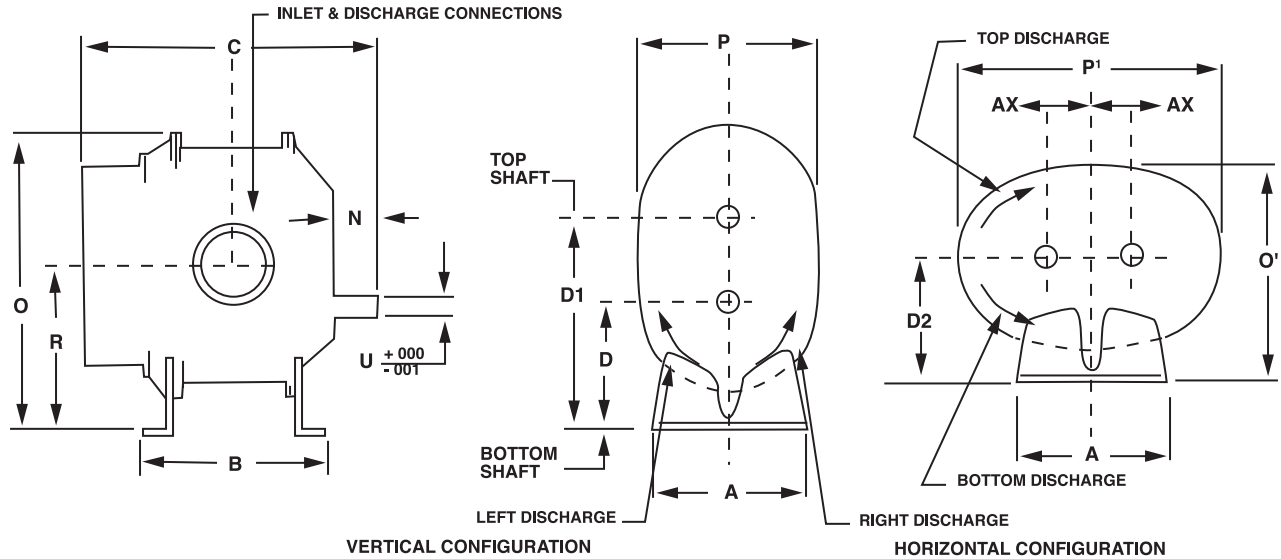

Universal RAI® Blower Dimensions

Frame Size	A	B	C	Drive Shaft Location			N	O	O'	P	P'	R	U	Keyway	Inlet & Disch. Dia.	AX	Approx Net Wt. (lbs.)
				D	D1	D2											
22	5.13	5.00	9.75	3.75	6.25	3.75	2.50	9.63	6.88	6.25	9.25	5.00	.625	.188 x .094	1.0 NPT	1.25	32
24	5.13	7.00	11.75	3.75	6.25	3.75	2.50	9.63	6.88	6.25	9.25	5.00	.625	.188 x .094	2.0 NPT	1.25	43
32	7.25	6.75	11.25	5.00	8.50	5.00	2.44	12.81	8.88	7.75	12.13	6.75	.750	.188 x .094	1.25 NPT	1.75	69
33	7.25	7.63	12.13	5.00	8.50	5.00	2.44	12.81	8.88	7.75	12.13	6.75	.750	.188 x .094	2.0 NPT	1.75	74
36	7.25	10.00	14.63	5.00	8.50	5.00	2.56	12.81	8.88	7.75	12.13	6.75	.750	.188 x .094	2.5 NPT	1.75	102
42	8.00	7.25	13.00	6.25	10.25	6.25	3.18	15.06	10.63	8.75	13.63	8.25	.875	.188 x .094	1.5 NPT	2.00	88
45	8.00	10.00	15.50	6.25	10.25	6.25	2.94	15.06	10.63	8.75	13.63	8.25	.875	.188 x .094	2.5 NPT	2.00	109
47	8.00	11.75	17.63	6.25	10.25	6.25	3.31	15.06	10.50	8.50	13.63	8.25	.875	.188 x .094	3.0 NPT	2.00	128
53	10.50	8.38	15.38	6.25	11.25	6.75	3.68	17.38	11.88	10.25	17.25	8.75	1.125	.250 x .125	2.5 NPT	2.50	143
56	10.50	11.00	18.00	6.25	11.25	6.75	3.38	17.38	12.25	11.00	17.25	8.75	1.125	.250 x .125	4.0 NPT	2.50	170
59	10.50	14.00	21.18	6.25	11.25	6.75	3.88	17.38	12.25	11.00	17.25	8.75	1.125	.250 x .125	4.0 NPT	2.50	204
65	11.00*	10.00	18.38	8.75	14.75	8.75	3.56	21.63	15.13	12.75	19.75	11.75	1.375	.312 x .156	3.0 NPT	3.00	245
68	11.00*	13.00	21.38	8.75	14.75	8.75	3.69	21.63	15.13	12.75	19.75	11.75	1.375	.312 x .156	5.0 NPT	3.00	285
615	11.00*	20.00	28.38	8.75	14.75	8.75	3.69	21.63	16.25	15.00	19.75	11.75	1.375	.312 x .156	6.0 FLG	3.00	425
76	14.00**	11.75	19.94	11.00	18.00	11	4.06	26.13	20.69	19.38	23.25	14.50	1.562	.375 x .188	4.0 NPT	3.50	400
711	14.00**	16.75	25.19	11.00	18.00	11	4.31	26.13	19.50	17.00	23.25	14.50	1.562	.375 x .188	6.0 FLG	3.50	530
718	14.00**	23.75	32.19	11.00	18.00	11	4.31	26.13	19.50	17.00	23.25	14.50	1.562	.375 x .188	8.0 FLG	3.50	650

*17.00 in horizontal configuration

**21.00 in horizontal configuration

Dresser Roots

Houston, Texas Headquarters • U.S. Toll Free Phone: 1 877-363-ROOT(S) (7668) • Direct Phone: +1 832-590-2600

Connersville, Indiana Operations • Direct Phone: +1 765-827-9200

European Operations • Phone: +44 (0) 1695 52600 • Email: roots.europe@dresser.com

USA/Canada Sales • Phone: +1 773-444-3360

Houston, Texas Factory Service • Phone: +1 713-896-4810

Mexico City Sales and Factory Service • Phone: +52 55 5889 5811

Dubai Sales and Factory Service • Phone: +971 4-8855481

Malaysia Sales • Phone: +60 3 2267 2600

China Sales • Phone: +86 10 8486 2440

Shanghai Factory Service • Phone: +86 21 5858 7638

©2010 Dresser, Inc. all rights reserved. • Printed in the U.S.A. • All information subject to change without notice. • Universal RAI is a registered trademark of Dresser, Inc. ROOTS is a trademark of Dresser, Inc.



www.dresserroots.com