



Enviro-Equipment Inc.
10120 Industrial Drive
Pineville NC 28134

Stock#: 1018

Dimensions: See Cut Sheet

Description: Rotron CP404FQ72JR Rotron Regenerative Blower, Stainless Steel Construction, 1HP 3PH 208-230/460V XP Motor, Max Vacuum 48" WC, Max Pressure 52" WC, Max Flow 100 SCFM



Environmental / Chemical Processing Blowers

EN 404 & CP 404

1.0 HP Sealed Regenerative w/Explosion-Proof Motor

ROTRON®

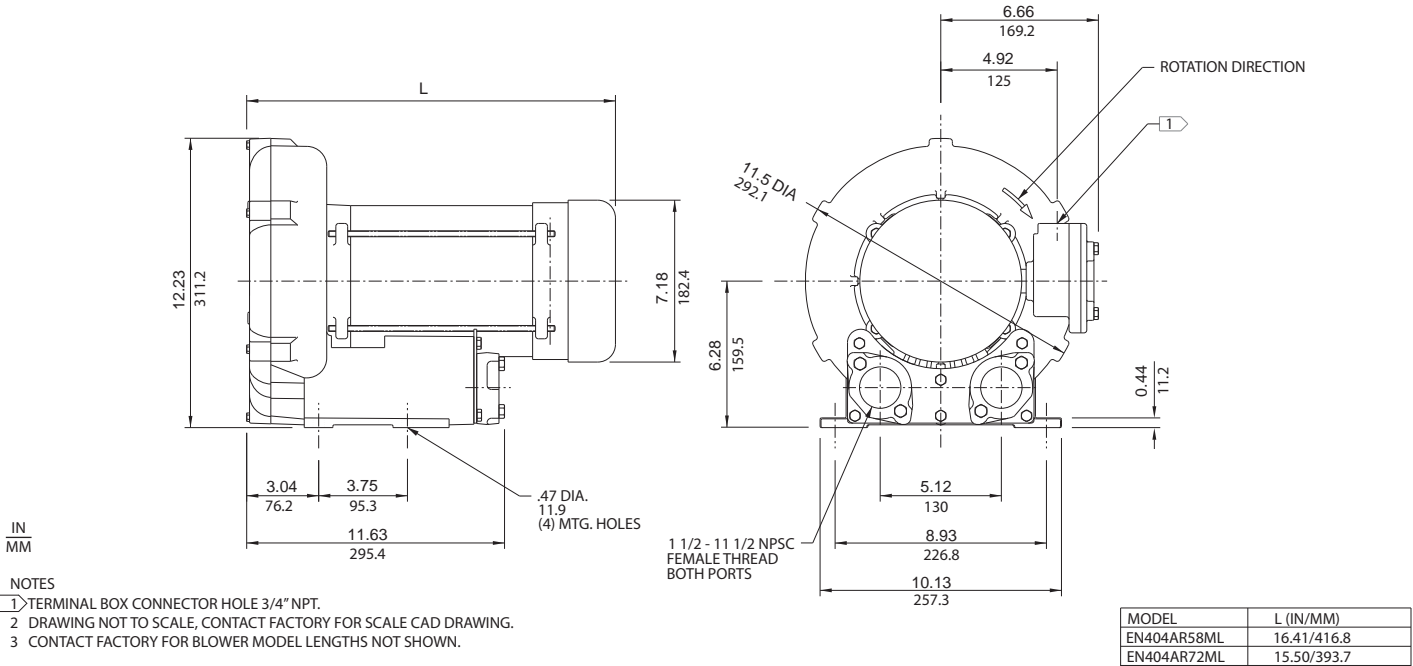

Specification	Units	Part/Model Number			
		EN404AR58ML 038173	EN404AR72ML 038174	CP404FQ58MLR 080075	CP404FQ72MLR 038958
Motor Enclosure - Shaft Mtl.	-	1.0	1.0	1.0	1.0
Horsepower	-	Explosion-proof-CS	Explosion-proof-CS	Chem XP-SS	Chem XP-SS
Phase - Frequency	-	Single-60 hz	Three-60 hz	Single-60 hz	Three-60 hz
Voltage	AC	115/230	208-230/460	115/230	208-230/460
Motor Nameplate Amps	Amps (A)	11.4/5.69	3.2/1.6	11.4/5.69	3.2/1.6
Max. Blower Amps	Amps (A)	14.4/7.2	3.6/1.8	14.4/7.2	3.6/1.8
Inrush Amps	Amps (A)	72/36	20.2/10.1	72/36	20.2/10.1
Service Factor	-	0/00	00/00	0/00	00/00
Starter Size	-	1.0	1.0	1.0	1.0
Thermal Protection	-	Class B - Pilot Duty	Class B - Pilot Duty	Class B - Pilot Duty	Class B - Pilot Duty
XP Motor Class - Group	-	I-D, II-F&G	I-D, II-F&G	I-D, II-F&G	I-D, II-F&G
Shipping Weight	Lbs	81	64	81	64
	Kg	36.7	29	36.7	29

Voltage - ROTRON motors are designed to handle a broad range of world voltages and power supply variations. Our dual voltage 3 phase motors are factory tested and certified to operate on both: **208-230/415-460 VAC-3 ph-60 Hz** and **190-208/380-415 VAC-3 ph-50 Hz**. Our dual voltage 1 phase motors are factory tested and certified to operate on both: **104-115/208-230 VAC-1 ph-60 Hz** and **100-110/200-220 VAC-1 ph-50 Hz**. All voltages above can handle a ±10% voltage fluctuation. Special wound motors can be ordered for voltages outside our certified range.

Operating Temperatures - Maximum operating temperature: Motor winding temperature (winding rise plus ambient) should not exceed 140°C for Class F rated motors or 120°C for Class B rated motors. Blower outlet air temperature should not exceed 140°C (air temperature rise plus inlet temperature). Performance curve maximum pressure and suction points are based on a 40°C inlet and ambient temperature. Consult factory for inlet or ambient temperatures above 40°C.

Maximum Blower Amps - Corresponds to the performance point at which the motor or blower temperature rise with a 40°C inlet and/or ambient temperature reaches the maximum operating temperature.

XP Motor Class - Group - See Explosive Atmosphere Classification Chart in Section I

This document is for informational purposes only and should not be considered as a binding description of the products or their performance in all applications. The performance data on this page depicts typical performance under controlled laboratory conditions. AMETEK is not responsible for blowers driven beyond factory specified speed, temperature, pressure, flow or without proper alignment. Actual performance will vary depending on the operating environment and application. AMETEK products are not designed for and should not be used in medical life support applications. AMETEK reserves the right to revise its products without notification. The above characteristics represent standard products. For product designed to meet specific applications, contact AMETEK Technical & Industrial Products Sales department.

FEATURES

- Manufactured in the USA - ISO 9001 and NAFTA compliant
- Maximum flow: 100 SCFM
- Maximum pressure: 52 IWG
- Maximum vacuum: 48 IWG
- Standard motor: 1.0 HP, explosion-proof
- Cast aluminum blower housing, impeller, cover & manifold; cast iron flanges (threaded); teflon® lip seal
- UL & CSA approved motor with permanently sealed ball bearings for explosive gas atmospheres Class I Group D minimum
- Sealed blower assembly
- Quiet operation within OSHA standards

MOTOR OPTIONS

- International voltage & frequency (Hz)
- Chemical duty, high efficiency, inverter duty or industry-specific designs
- Various horsepower for application-specific needs

BLOWER OPTIONS

- Corrosion resistant surface treatments & sealing options
- Remote drive (motorless) models
- Slip-on or face flanges for application-specific needs

ACCESSORIES

- Flowmeters reading in SCFM
- Filters & moisture separators
- Pressure gauges, vacuum gauges, & relief valves
- Switches - air flow, pressure, vacuum, or temperature
- External mufflers for additional silencing
- Air knives (used on blow-off applications)
- Variable frequency drive package



Blower Performance at Standard Conditions

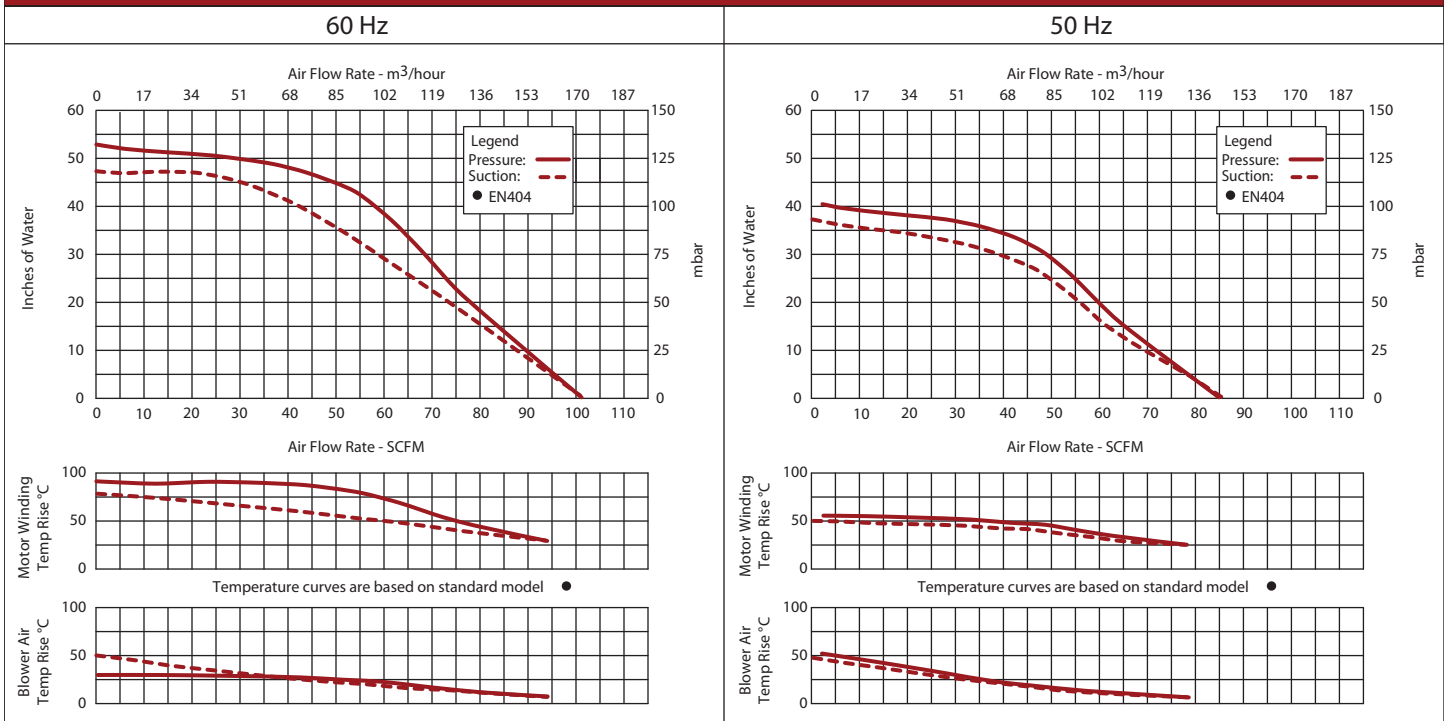

This document is for informational purposes only and should not be considered as a binding description of the products or their performance in all applications. The performance data on this page depicts typical performance under controlled laboratory conditions. AMETEK is not responsible for blowers driven beyond factory specified speed, temperature, pressure, flow or without proper alignment. Actual performance will vary depending on the operating environment and application. AMETEK products are not designed for and should not be used in medical life support applications. AMETEK reserves the right to revise its products without notification. The above characteristics represent standard products. For product designed to meet specific applications, contact AMETEK Technical & Industrial Products Sales department.