



Enviro-Equipment Inc.
10120 Industrial Drive
Pineville NC 28134

Stock#: 802

Status: In Stock, Tested

Dimensions: See cut sheet below

Description: Rotron DR707F72X Regenerative Blower with 5HP 3PH 230/460V XP Motor



DR 707 Regenerative Blower

FEATURES

- Manufactured in the USA
- Maximum flow 280 SCFM
- Maximum pressure 11.4" WG
- Maximum vacuum 6.8" Hg
- 5 HP standard
- Blower construction—cast aluminum housing, impeller and cover
- Inlet and outlet internal muffling
- Noise level within OSHA standards
- Weight: 156 lbs. (71 Kg)

ACCESSORIES

- External mufflers
- Slip-on flanges
- Inlet and/or inline filters
- For details see Accessories Section

OPTIONS

- Smaller HP motors
- 575-volt and XP motors
- Surface treatment or plating
- Single or three phase motors
- Remote drive (motorless) model
- Gas tight sealing
- Belt drive (motorless) model;
- For details see Remote Drive Section

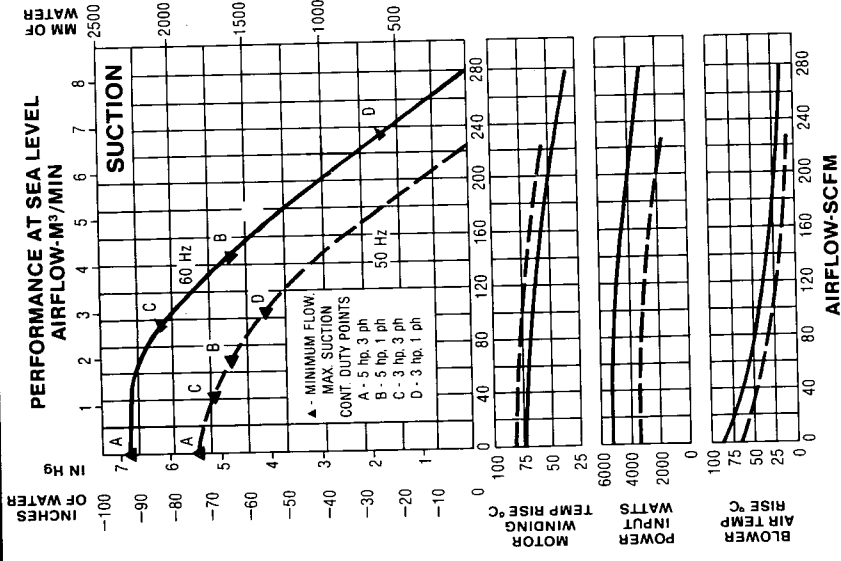
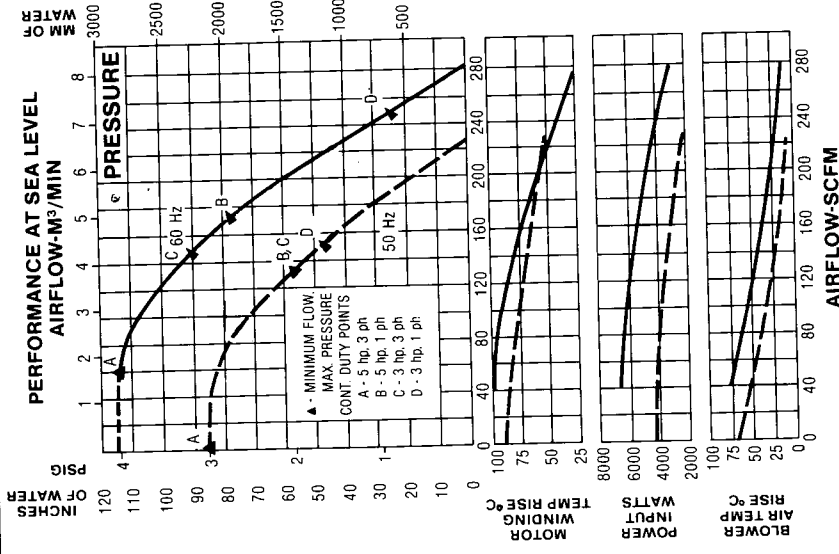
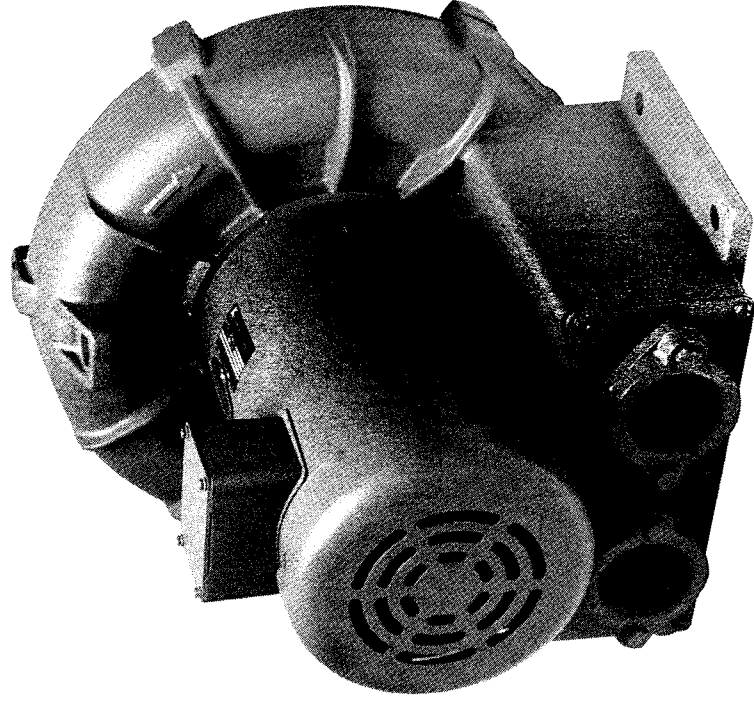

DR 707 Regenerative Blower

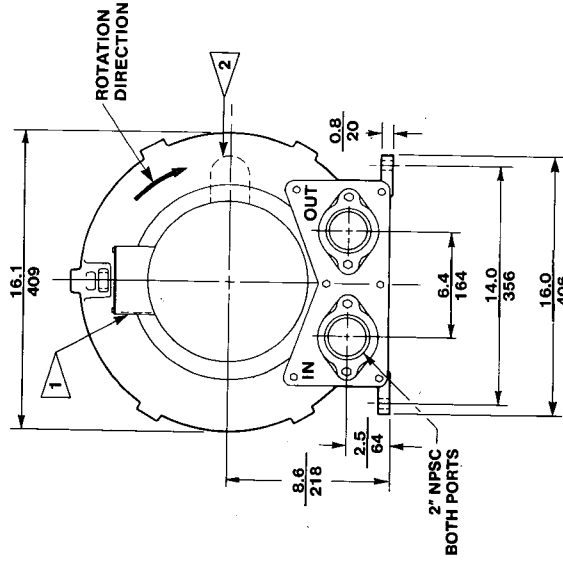
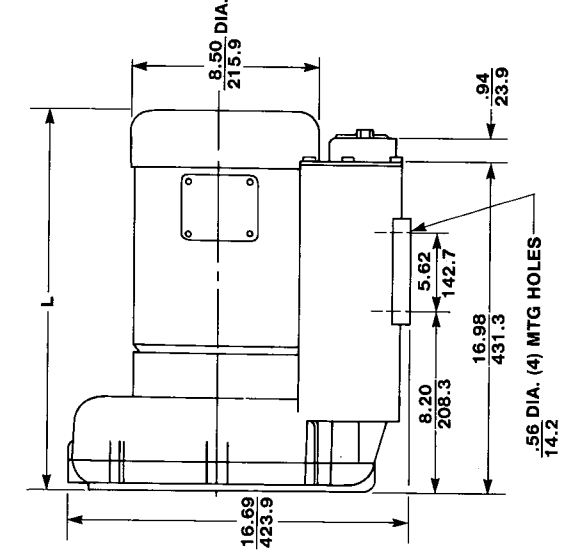

Model	L (IN)	L (MM)
DR707D89X	18.17	461.5
DR707K72X	18.17	461.5
DR707F72X	20.49	520.4
DR70786X	18.17	461.5
DR707D5X	19.67	499.6
DR707K9X	17.5	444.5

- 1 T-BOX CONNECTION 1.06" DIA. ON TEFC MOTORS, .75 NPT ON XP MOTORS
- 2 LOCATION OF CAPACITOR ON SINGLE PHASE MOTORS

DIMENSIONS: IN
TOLERANCE: .XX ± .1
2.5

Specifications subject to change without notice.

SPECIFICATIONS

MODEL	DR707D89X	DR707K72X	DR707F72X	DR707D86X	DR707D5X	DR707K9X
Part No.	036789	036791	036790	036794	036875	036794
Motor Enclosure Type	TEFC	TEFC	XP	TEFC	TEFC	TEFC
Motor Horsepower	5	3	5	5	5	3
Voltage ¹	208-230/460	230/460	230/460	575	230	115/230
Phase	3	3	3	3	1	1
Frequency ¹ (Hz)	60	60	60	60	60	60
Insulation Class ²	F	F	B	F	F	F
NEMA Rated Motor Amps	14.2-14.0/7.0	8.0/4.0	14.0/7.0	5.6	21	26.2/13.1
Service Factor	1.15	1.15	1.0	1.15	1.0	1.0
Locked Rotor Amps	98-96/48	52/26	96/48	37	124	158/79
Max. Blower Amps	18.5-18.2/9.1	13/6.5	14.0/7.0	6.9	25	18.5/9.25
Recommended NEMA Starter Size	1-1/0	0/0	1/0	0	1.5	1.5/1
Weight (lbs/Kg)	169/76.8	157/71.4	184/83.6	169/76.8	194/88.2	186/84.5
Blower Limitations for Continuous Duty (60 Hz/50 Hz)						
Max. Pressure-in. of water	113/83	90/65	100/75	113 (60 Hz)	77/65	25/55
Max. Suction-in. of water	93/73	83/70	82/70	93 (60 Hz)	65/65	25/55
Min. Flow-Pressure-SCFM	60/0	145/120	120/88	60 (60Hz)	175/120	245/130
Min. Flow-Suction-SCFM	0/0	97/40	100/44	0 (60 Hz)	145/70	230/105

¹All 3 phase motors are factory tested and certified to operate on 200-230/460 VAC-3 ph-60 Hz and 220-240/380-415 VAC-3 ph-50 Hz.
²Maximum operating temperatures: Motor winding temperature (winding rise plus ambient) should not exceed 140°C for Class F insulation or 110°C for Class B insulation. Blower outlet air temperature should not exceed 140°C (air temperature rise plus ambient).