



Enviro-Equipment Inc.
10120 Industrial Drive
Pineville NC 28134

Stock#: 769

Status: In stock

Dimensions: 2.5"x2.5"x48"

Weight: 16 lbs

Description: QED AP3 Short Top Load

1" discharge

3/8" inlet/outlet

Top fed

Stainless material



AP3T

AutoPump®

Top Inlet, Short

Max. Flow 4.8 gpm (18.1 lpm)

O.D. 3.4 in. (8.64 cm)

Length 47 in. (119 cm)

Description

The AP3T Top Inlet Short AutoPump is designed for moderate-duty remediation pumping applications with well casings 3" (7.62 cm) diameter and larger using available 2.63" (6.68 cm) inlet. It is designed for applications requiring an elevated inlet, such as pumping total fluids from wells contaminated with LNAPLs. Call QED for prompt, no-obligation assistance on your pumping project needs.

The AutoPump Heritage

The AP3T Top Inlet Short AutoPump is part of the famous AutoPump family of original automatic air-powered pumps, developed in the mid 1980s specifically to handle unique pumping needs at remediation and landfill sites. Over the years they've proven their durability at thousands of sites worldwide. AutoPumps are designed to handle difficult pumping challenges that other pumps can't, such as solvents, suspended solids, corrosives, temperature extremes, viscous fluids and frequent start/stop cycles. Beyond just the pump, AutoPump systems offer the most complete range of tubing, hose, connectors, caps and accessories to help your installation go smoothly. This superior pumping heritage, application experience and support back up every AutoPump you put to work on your project.

Advantages

1. Based on the original automatic air-powered well pump, proven worldwide over 25 years
2. Competitive flow rates and pumping capabilities
3. Patented, proven design for superior reliability and durability
4. Handles solids, some solvents, hydrocarbons and corrosive conditions beyond the limits of electric pumps
5. Two-year warranty



Pump Dimensions

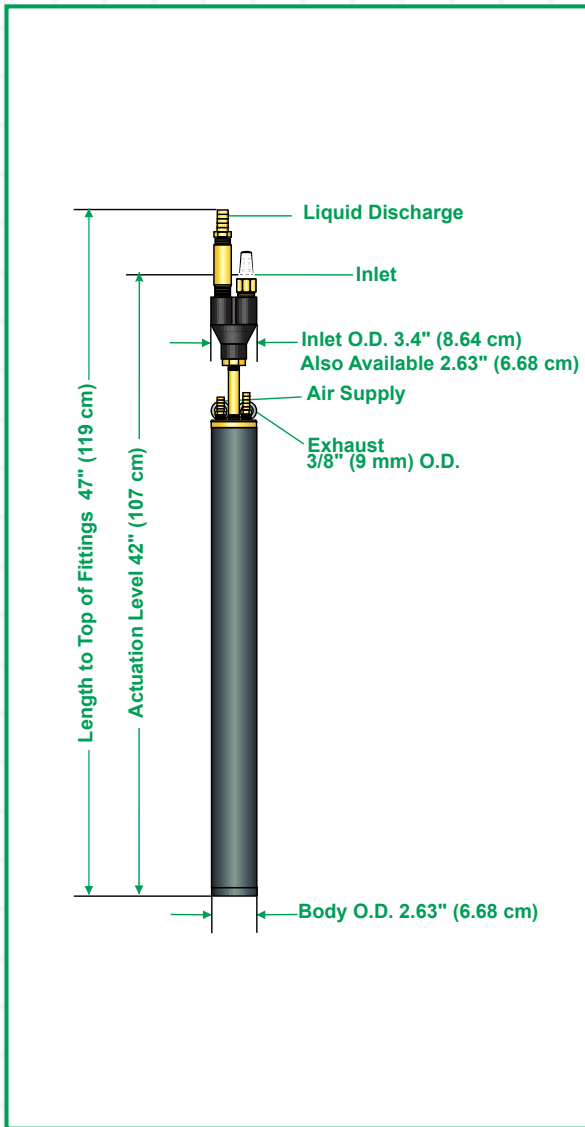

Specifications & Operating Requirements

Model	3" - Short AP3 Top Inlet
Liquid Inlet Location	Top
OD	3.4 in. (8.64 cm) (2.63 in. Available)
Length Overall (pump & fittings)	47 in. (119 cm)
Weight	10 lbs. (4.5 kg)
Max. Flow Rate	4.8 gpm (18.1 lpm) - See Flow Rate Chart
Pump Volume / Cycle	0.08 - 0.15 gal (.30 - 0.57L)
Max. Depth	175 ft. (53.3 m)
Air Pressure Range	5 -80 psi (0.4 - 5.6 kg/cm ²)
Min. Actuation Level	42 in. (107 cm)
Air Usage	0.43 -1.6 scf / gal.(3.2 - 12.0 liters of air / fluid liter) - See Air Usage Chart
Min. Liquid Density	0.7 SpG (0.7 g/cm ³)
Standard Construction Materials	
Pump Body	Fiberglass or Stainless Steel
Pump Ends	Stainless Steel, Acetal, HDPE, Brass
Internal Components	Stainless Steel, Viton, Acetal, Nylon
Tube & Hose Fittings	Brass or Stainless Steel
Fitting Type	Barbs or Quick Connects
Tube Options	
Tubing Material	Nylon
Sizes¹ - Liquid Discharge	3/4 in. (19 mm) or 1 in. (25 mm) OD
Pump Air Supply	1/2 in. (13 mm) OD
Air Exhaust	5/8 in. (16 mm) OD

¹ Applies to QED supplied tubing; other tubing sources may not conform to QED fittings.

Application Limits

AP3 AutoPumps are designed to handle the application ranges described below. For applications outside this range, consider the AP4 and AP2 models.

Maximum Temperature: 120°F (49°C)

pH Range: 4-9

Solvents and Fuels: gasoline, diesel fuel, BTEX, MTBE

AP3 AutoPumps are warranted for two (2) years: 100% materials and workmanship.

Flow Rates¹

.75 inch (19 mm) O.D. Fluid Discharge Tubing

1.00 inch (25 mm) O.D. Fluid Discharge Tubing

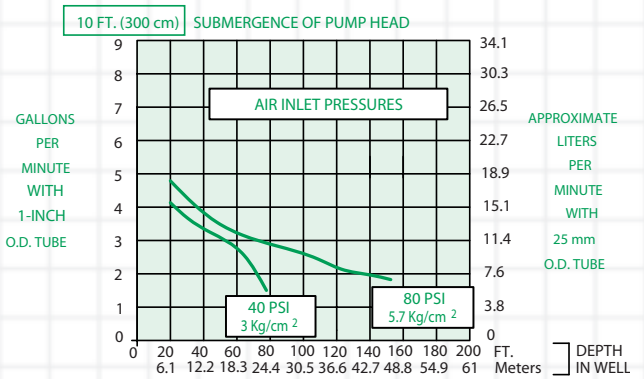
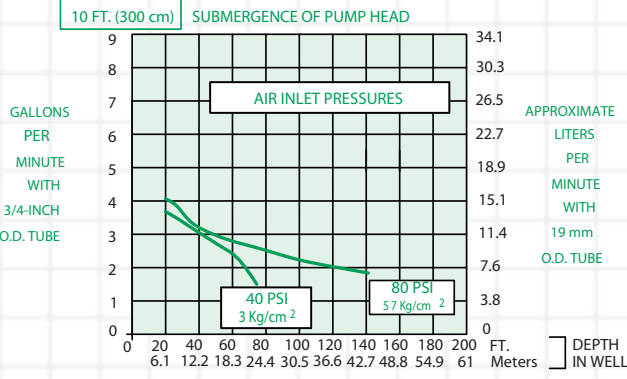
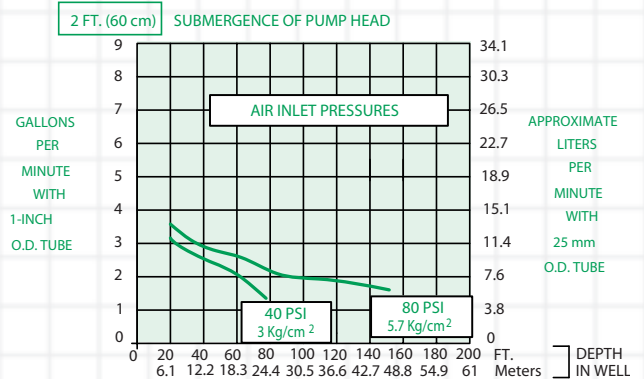
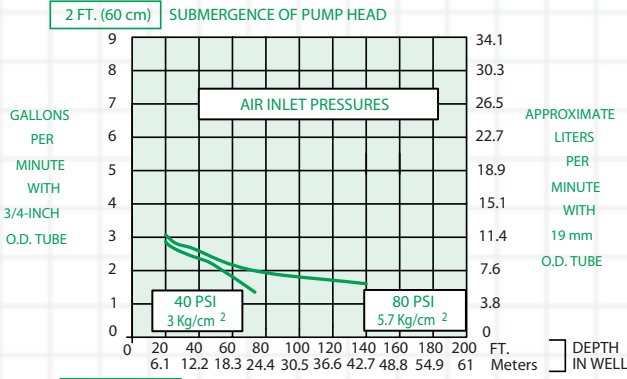
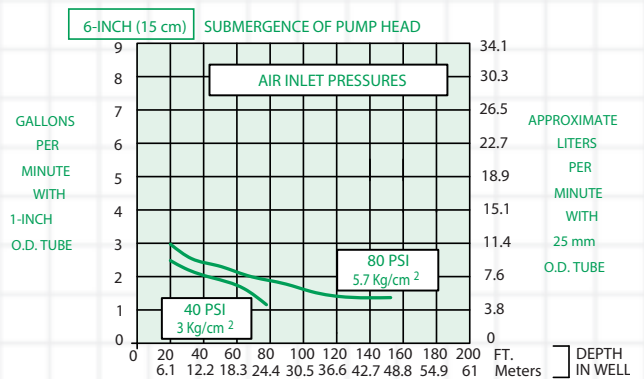
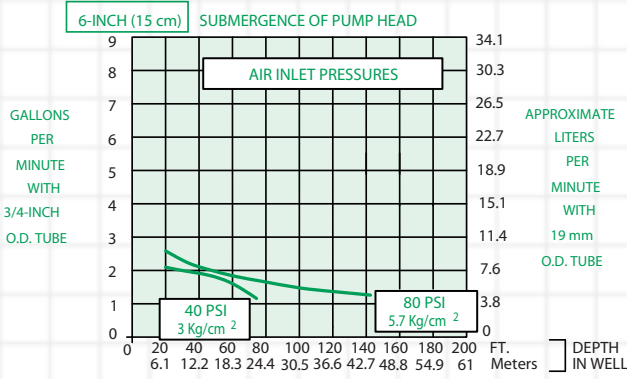

¹ FLOW RATES MAY VARY WITH SITE CONDITIONS. CALL QED FOR TECHNICAL ASSISTANCE.

Air Consumption



STANDARD
CUBIC FEET OF AIR
PER
GALLON PUMPED
(SCF/GAL)

STANDARD
CUBIC FEET OF AIR
PER
GALLON PUMPED
(SCF/GAL)

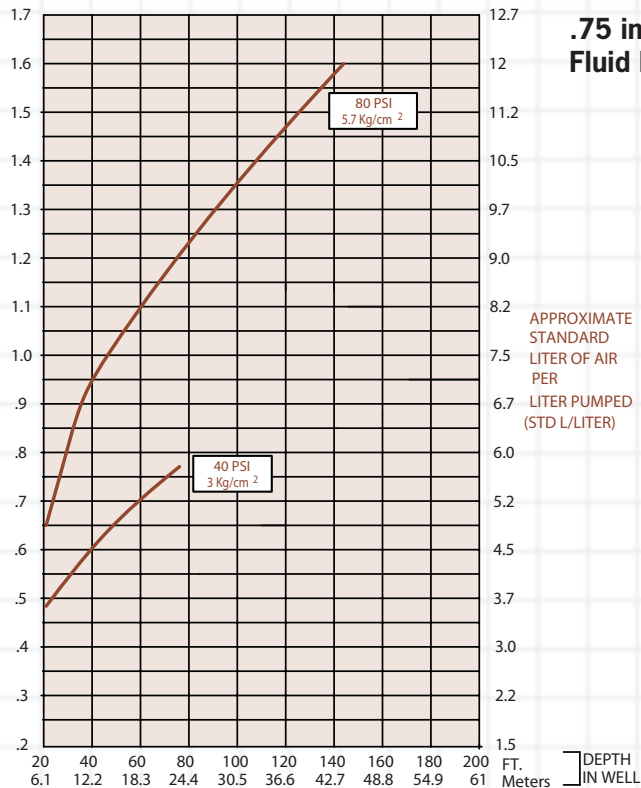

**.75 inch (19 mm) O.D.
Fluid Discharge Tubing**

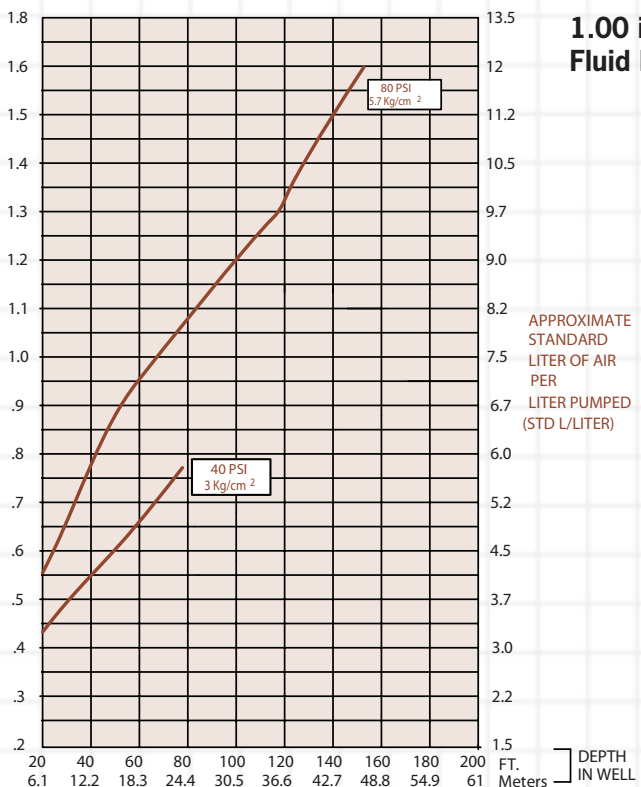

**1.00 inch (25 mm) O.D.
Fluid Discharge Tubing**