

# Geotech 3.5” Auto-Reclaimer

Installation and Operation Manual





## Table of Contents

Section 1: System Description .....	3
Function and Theory .....	3
Section 2: System Installation .....	6
Section 3: System Operation .....	10
Section 4: System Maintenance .....	11
Section 5: System Troubleshooting .....	24
Section 6: System Specifications .....	25
Section 7: System Schematics .....	33
Section 8: Parts List .....	36
Warranty and Repair .....	40

# DOCUMENTATION CONVENTIONS

This uses the following conventions to present information:



**WARNING**

An exclamation point icon indicates a **WARNING** of a situation or condition that could lead to personal injury or death. You should not proceed until you read and thoroughly understand the **WARNING** message.



**CAUTION**

A raised hand icon indicates **CAUTION** information that relates to a situation or condition that could lead to equipment malfunction or damage. You should not proceed until you read and thoroughly understand the **CAUTION** message.



**NOTE**

A note icon indicates **NOTE** information. Notes provide additional or supplementary information about an activity or concept.

## Section 1: System Description

### Function and Theory

The Geotech 3.5" Auto-Reclaimer (from here on called the 3.5 AR) is a fixed intake, automatic total fluids recovery pump which can recover fluids from depths of up to 500 ft. Geotech provides three pump lengths; 36", 48" and 60", which can be built to operate as a top fill, bottom fill, or dual (top/bottom) fill system. Figure 1-1 shows an example of the three model types.

The 3.5 AR is an automatic and controllerless, positive air-displacement pump that works without the use of any external controls, relays, bleeder tubes or bubblers. The 3.5 AR requires only a regulated compressed air source to operate with an operating pressure of only 1 PSI above static head. The 3.5 AR does not require clean, dry air to function properly and can operate on a standard industrial air source.

The 3.5 AR can also operate under both positive and \*negative (vacuum) pressure environments. The pump is designed to self-adjust the discharge flow rate automatically to match individual well recharge rates (up to the pumps maximum capacity based on depth, air pressure and flow.)



The 3.5 AR will pump large particulates up to 1/8" in diameter without plugging the discharge assembly. The unique single, self-cleaning valve mechanism will pass high viscosity gear oils without fouling.

\*Vacuum conditions may require a Vacuum Equalizer if venting out of the recovery well. Contact your Geotech Technical Sales representative for more information.

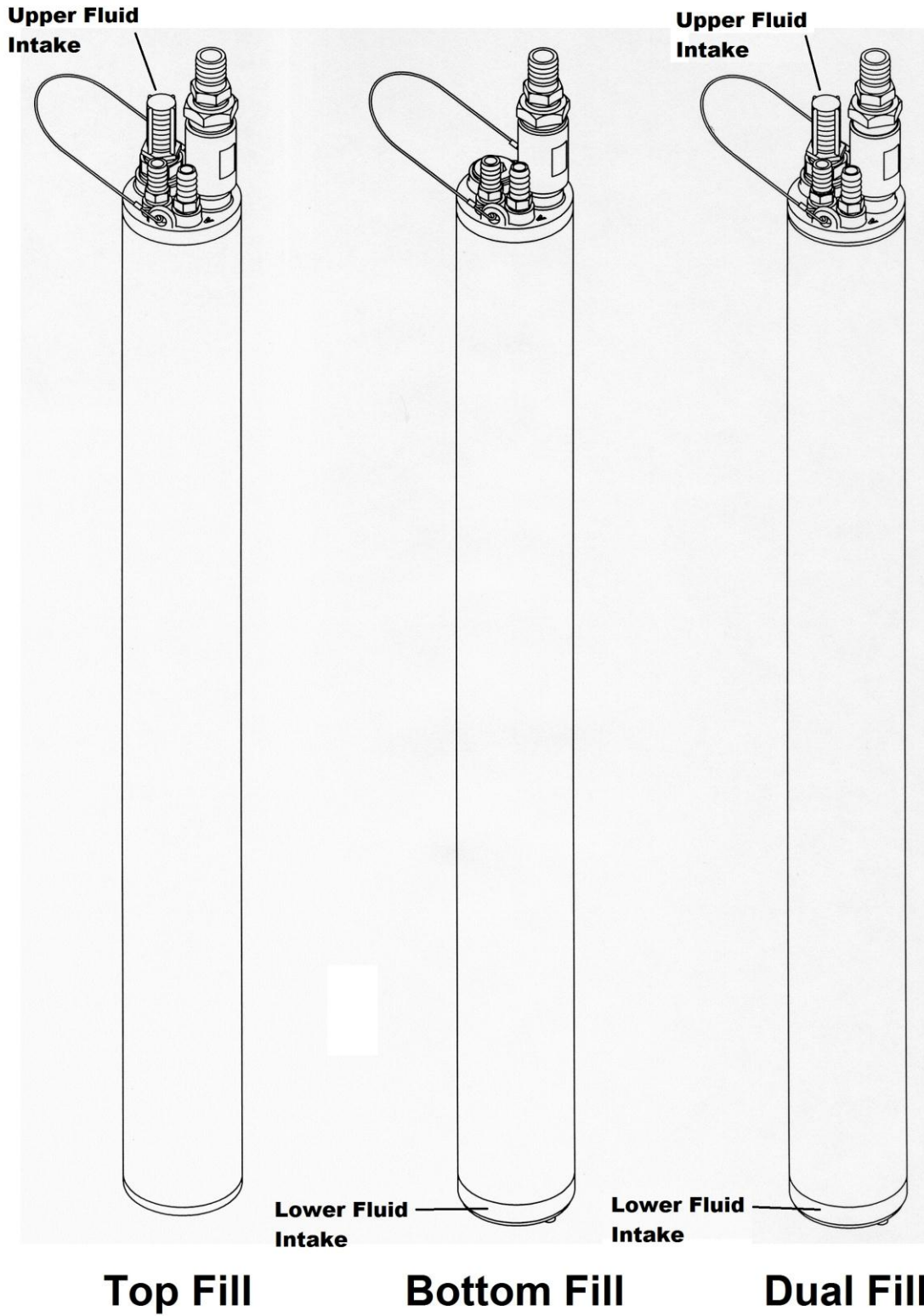

Figure 1-1 3.5 Auto-Reclaimer Models

## System Components

The 3.5 AR components consist of an Upper Head Valve Assembly, Internal Float Assembly, Bottom Fluid Intake Assembly (Bottom and Dual Fill models) and an Upper Fluid Intake Assembly (Top and Dual Fill models). Figure 1-2 is an example of the 3.5 AR with the housing detached.

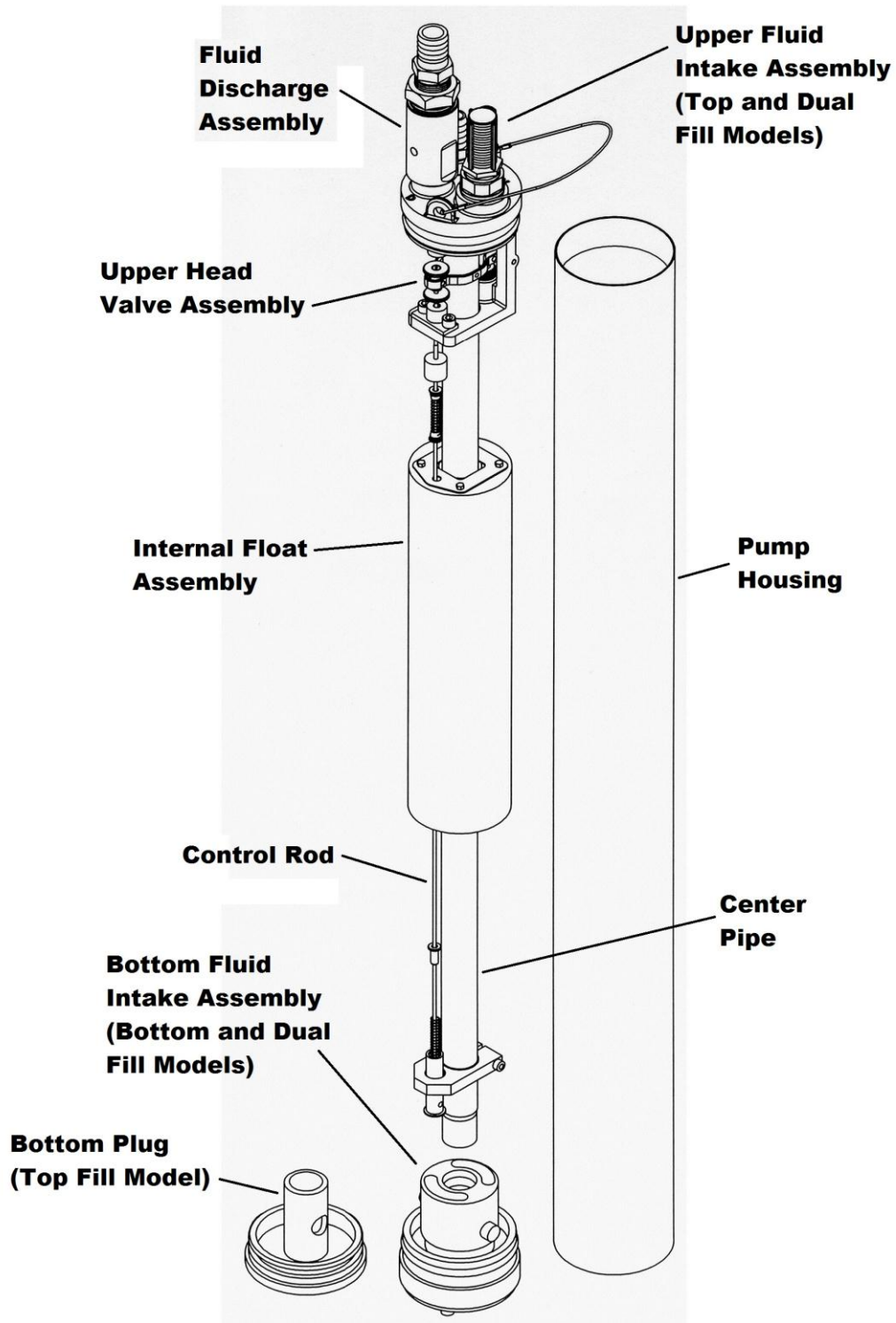

Figure 1-2 3.5 Auto-Reclaimer components

## Section 2: System Installation

### Top Fill

Attach the Air, Vent, and Discharge hoses to the labeled barbed fittings (see Figure 2-1). Ensure that all hoses are installed securely and completely. (Standard fitting sizes, Vent 1/2", Air supply 3/8", Discharge 3/4").

Attach the pump suspension cable to the pump head hanger cable. Ensure the attachment method is secure and tight before lowering the pump into the recovery well.

Once the top fill pump is lowered into the well where the Upper Fluid Intake is submerged below the static groundwater conditions, the fluid will enter through the submerged intake, filling the housing and is then pumped to the surface (see also Figure 2-3).

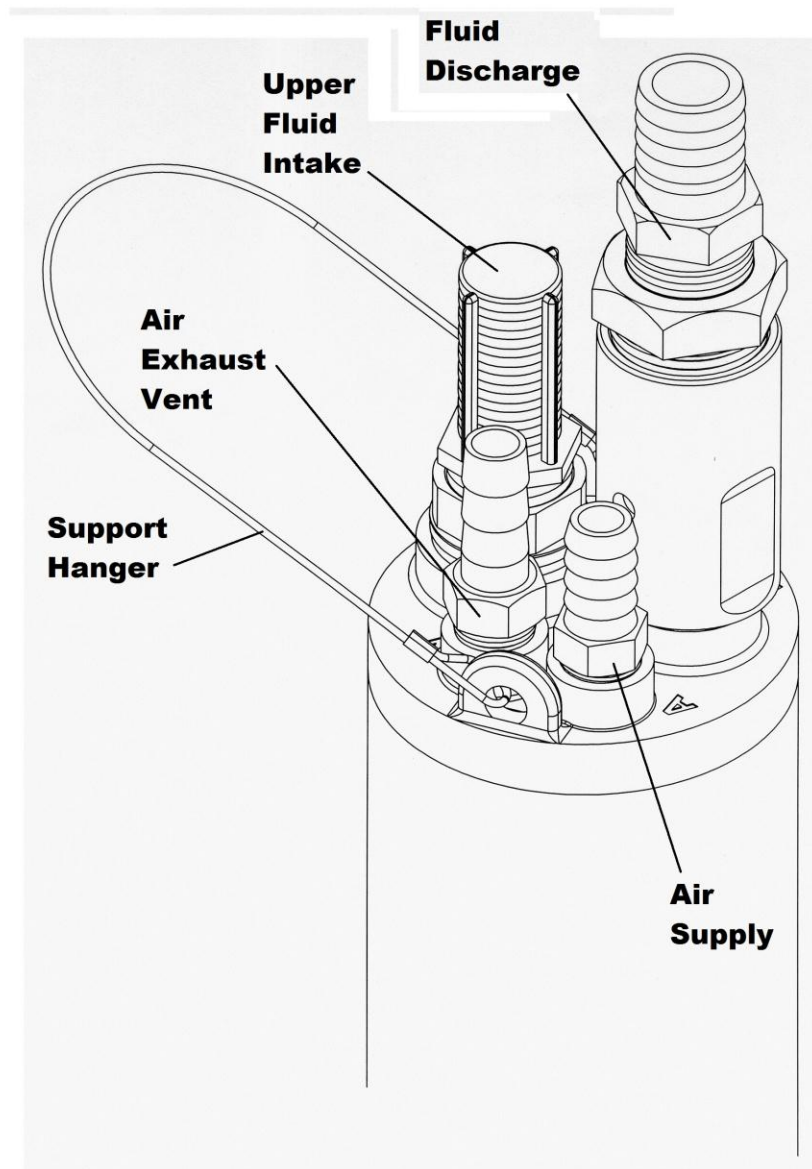

Figure 2-1 Top Fill Auto-reclaimer components



## Bottom Fill

Attach the Air, Vent, and Discharge hoses to the labeled barbed fittings (see Figure 2-2). Ensure that all hoses are installed securely and completely. (Standard fitting sizes, Vent 1/2", Air supply 3/8", Discharge 3/4").

Attach the pump suspension cable to the pump head hanger cable. Ensure the attachment method is secure and tight before lowering the pump into the recovery well.

Once the bottom fill pump is lowered into the well where the Bottom Fluid Intake and the pump head of the unit are submerged below the static groundwater conditions, the fluid will enter through the bottom intake, filling the housing and is then pumped to the surface (see also Figure 2-4).

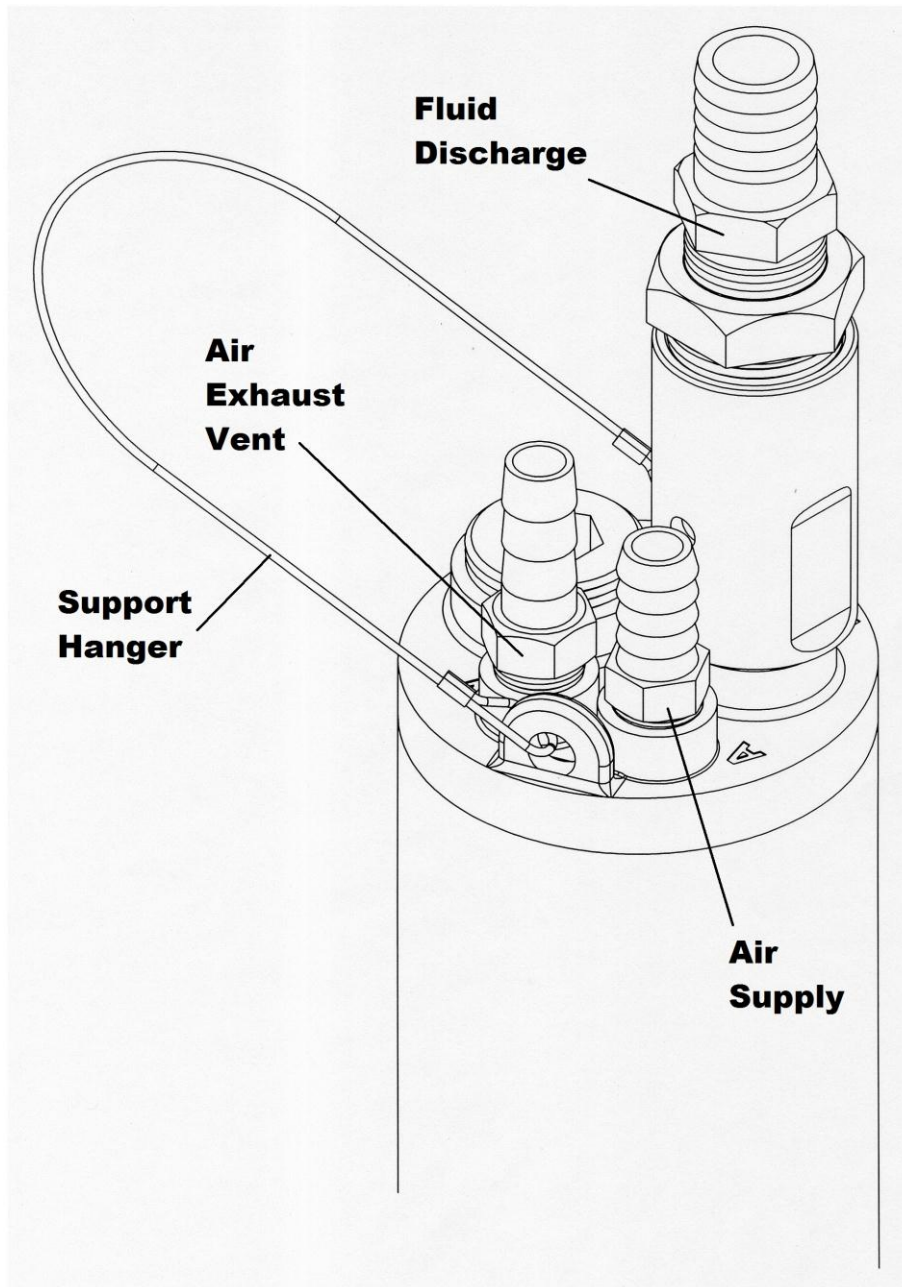

Figure 2-2 Top Fill Auto-reclaimer components

## Dual (Top/Bottom) Fill

Attach the Air, Vent, and Discharge hoses to the labeled barbed fittings (see Figure 2-1). Ensure that all hoses are installed securely and completely. (Standard fitting sizes, Vent 1/2", Air supply 3/8", Discharge 3/4").

Attach the pump suspension cable to the pump head hanger cable. Ensure the attachment method is secure and tight before lowering the pump into the recovery well.

Once the dual fill pump is lowered into the well where the Upper Fluid Intake is submerged below the static groundwater conditions, the fluid will enter through the submerged upper and lower intake assemblies, filling the housing and is then pumped to the surface.

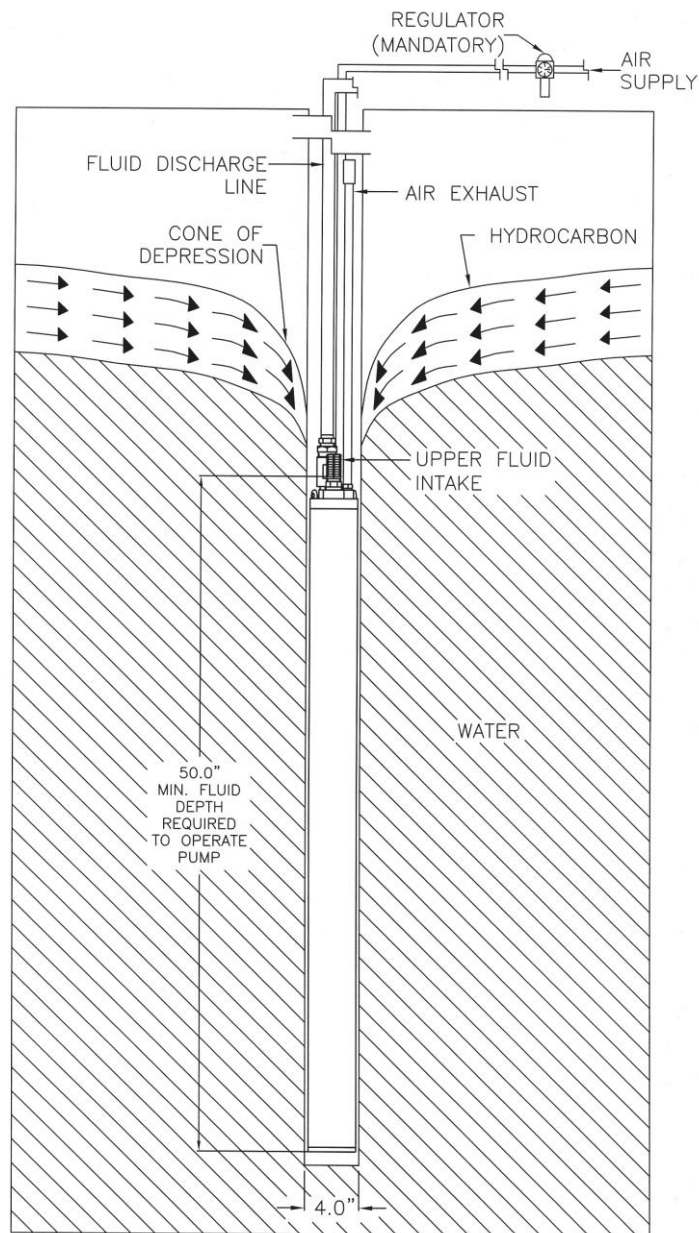

Figure 2-3 48" Top Fill Auto-reclaimer in the well

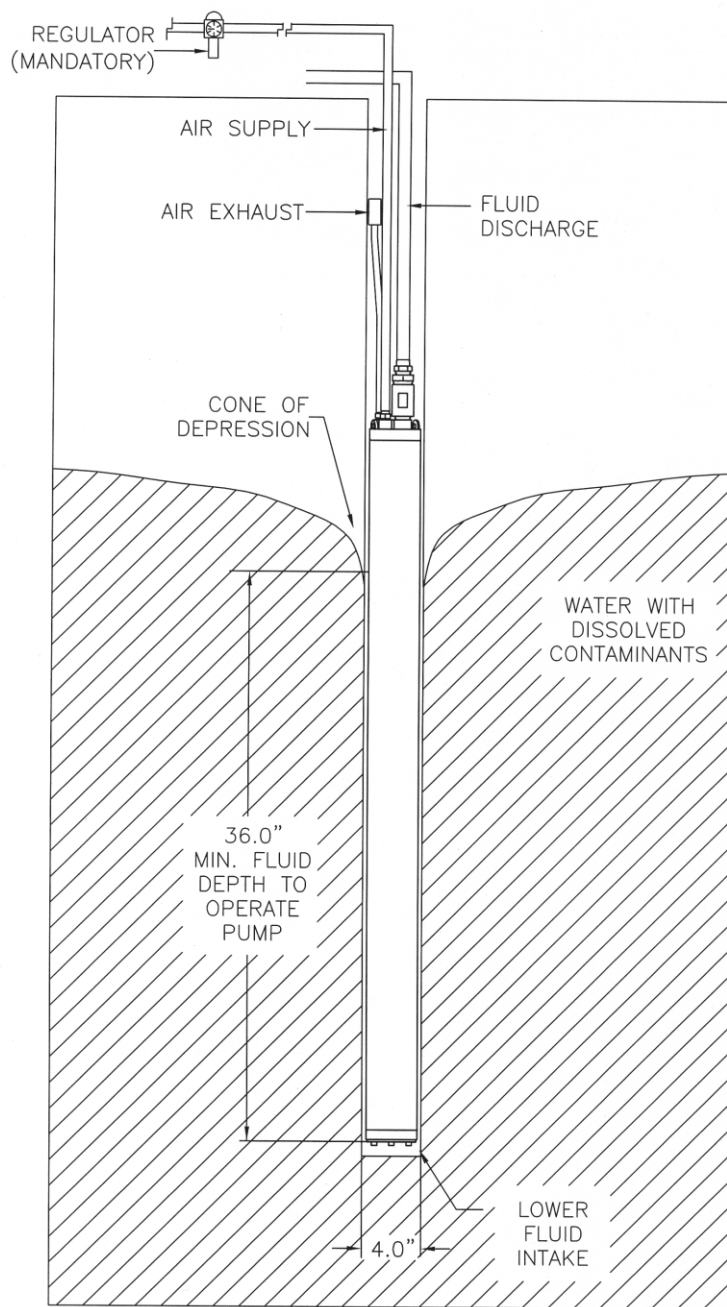

Figure 2-4 48" Bottom Fill Auto-reclaimer in the well



Depending on the well depth and viscosity of the fluid, it may be necessary to adjust the air pressure to the unit.

## Section 3: System Operation



Compressed air is utilized in this system as an on demand supply. Typically, .6 - .75 cubic feet of air is necessary per gallon of liquid pumped.

### Top Fill

The Top Fill 3.5 AR is placed in a recovery well with the Upper Fluid Intake assembly on the head submerged below the static groundwater level. Provided with a regulated air supply, the pump cyclically fills and empties. As the pump fills, the internal float assembly rises until it comes in contact with an upper stop that is connected to a mechanical rocker assembly. The rocker assembly shifts upward and simultaneously opens the air supply valve. The resulting effect is air pressure builds within the pump housing, closes the check ball within the upper intake assembly, and displaces the fluids up and out of the pump through the center pipe and discharge ball check valve.

As the pump discharge cycle progresses, the float assembly falls. The float assembly contacts the lower stop, which triggers the rocker assembly downward, closing the air supply valve and opening the air exhaust valve. The pressurized air exits out of the air exhaust tube, allowing the pump to refill and begin a new cycle. This cyclic operation continues automatically as fluid is drawn into the well.

### Bottom Fill

The Bottom Fill 3.5 AR is placed in a recovery well with the Bottom Intake assembly submerged the length of the unit below the static groundwater level. Provided with a regulated air supply, the pump cyclically fills and empties. As the pump fills, the internal float assembly rises until it comes in contact with an upper stop that is connected to a mechanical rocker assembly. The rocker assembly shifts upward and simultaneously opens the air supply valve. The resulting effect is air pressure builds within the pump housing, closes the check ball within the bottom intake assembly, and displaces the fluids up and out of the pump through the center pipe and discharge ball check valve.

As the pump discharge cycle progresses, the float assembly falls. The float assembly contacts the lower stop, which triggers the rocker assembly downward, closing the air supply valve and opening the air exhaust valve. The pressurized air exits out of the air exhaust tube, allowing the pump to refill and begin a new cycle. This cyclic operation continues automatically as fluid is drawn into the well.

### Dual (Top/Bottom) Fill

The Dual Fill 3.5 AR is placed in a recovery well with the Upper and Bottom Intake assemblies submerged below the static groundwater level. Provided with a regulated air supply, the pump cyclically fills and empties. As the pump fills, the internal float assembly rises until it comes in contact with an upper stop that is connected to a mechanical rocker assembly. The rocker assembly shifts upward and simultaneously opens the air supply valve. The resulting effect is air pressure builds within the pump housing, closes the check ball within the upper and lower intake assemblies, and displaces the fluids up and out of the pump through the center pipe and discharge ball check valve.

As the pump discharge cycle progresses, the float assembly falls. The float assembly contacts the lower stop, which triggers the rocker assembly downward, closing the air supply valve and opening the air exhaust valve. The pressurized air exits out of the air exhaust tube, allowing the pump to refill and begin a new cycle. This cyclic operation continues automatically as fluid is drawn into the well.

## Section 4: System Maintenance

Every 3-4 months or when deemed necessary, depending on fluids being pumped, the 3.5 AR should be removed from the well and cleaned inside and out. This can be accomplished using a grease cutting solvent or industrial cleaner, such as Alconox, Liquinox, or Simple Green. The float assembly should be checked for product absorption, saturation, or loose screws on float plates. Inspect for proper spring geometry (broken springs or over compressed) and damaged o-rings.



The 3.5 AR does not require clean dry air to operate. However, using dirty particulate filled air can increase maintenance frequency.

After the unit has been cleaned, perform a visual on the gap settings to the magnets and that the rocker arm has smooth activation when the float is brought up and down. Use the following procedures for any needed valve adjustments.

### Gap Setting Procedure

Remove the (3) cap screws holding on the intake screen (Figure 4-1). This is done with a 3/16" Allen wrench. If you have a top fill only reclaimer there will not be a screen (Figure 4-2). Use a spanner wrench to remove the bottom intake assembly or bottom plug, as the case may be (Figure 4-3).

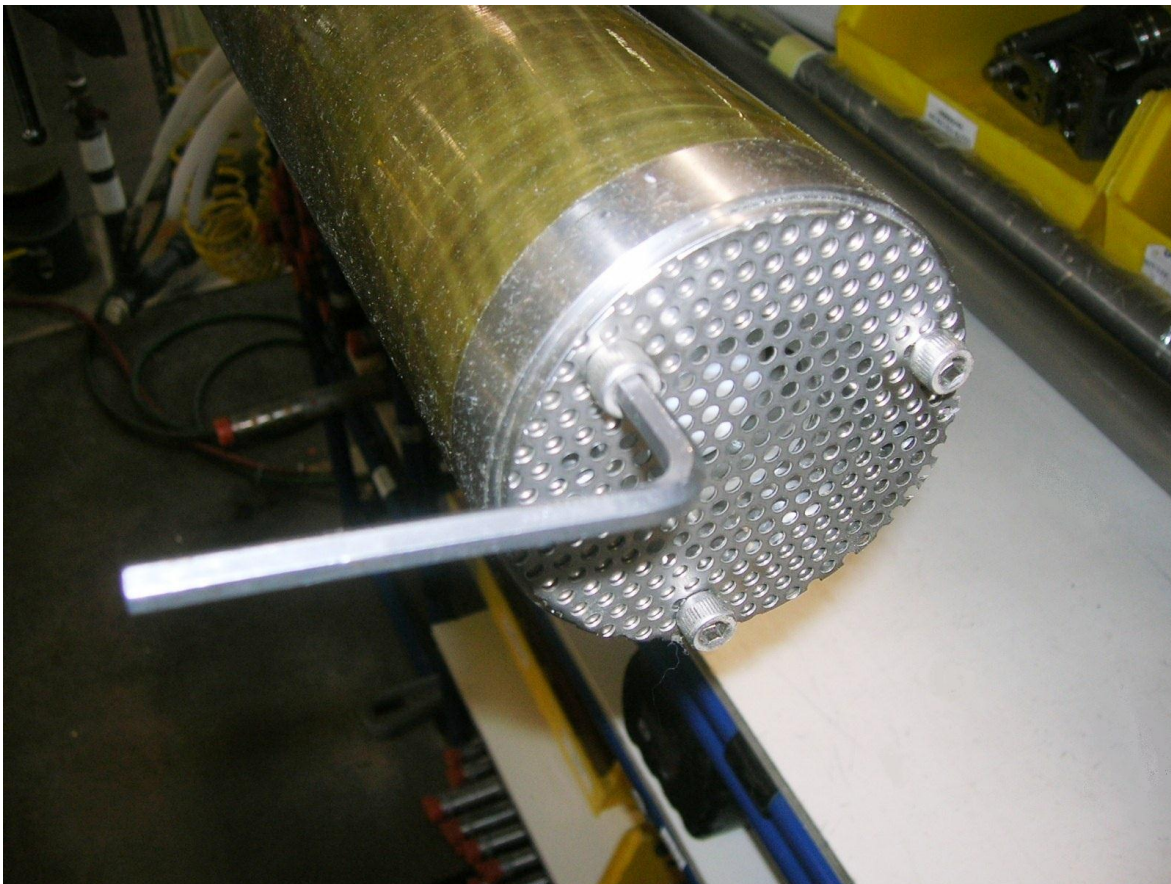

Figure 4-1



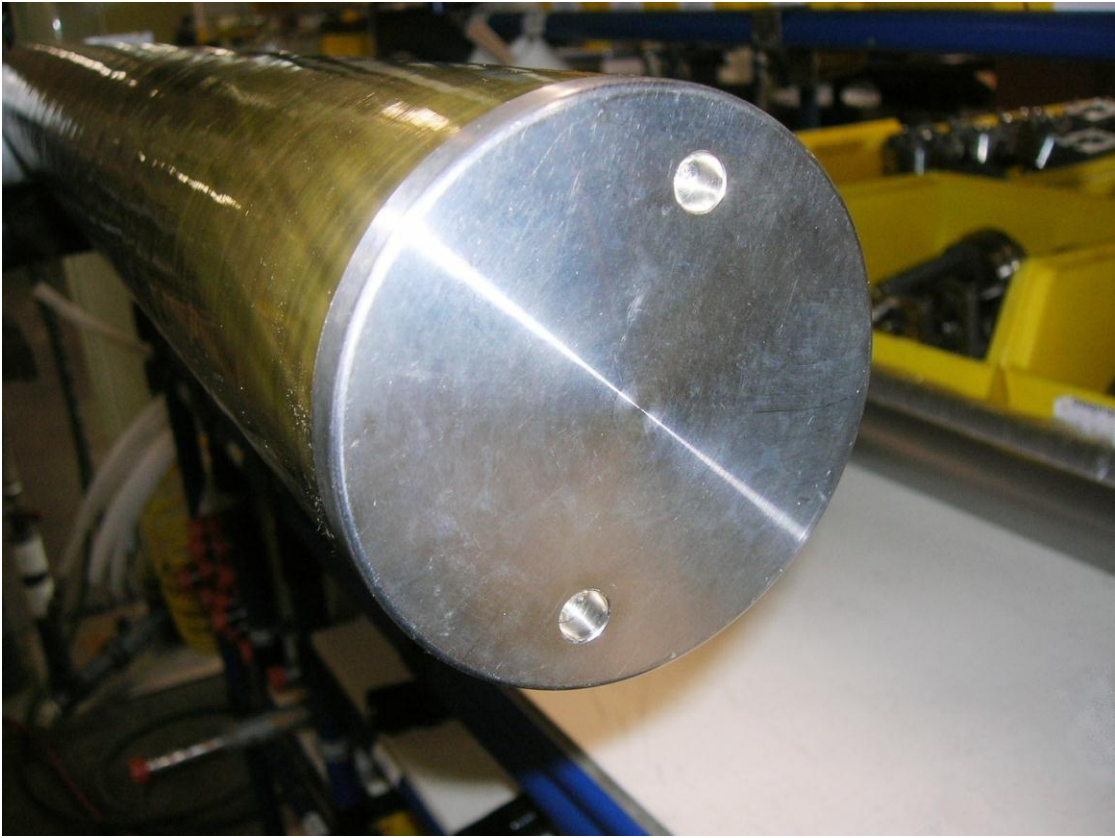

Figure 4-2



Figure 4-3

With the pump head in a vise, remove the outer housing by gripping it with both hands and firmly twisting and sliding the housing off the bottom end of the pump (Figure 4-4).

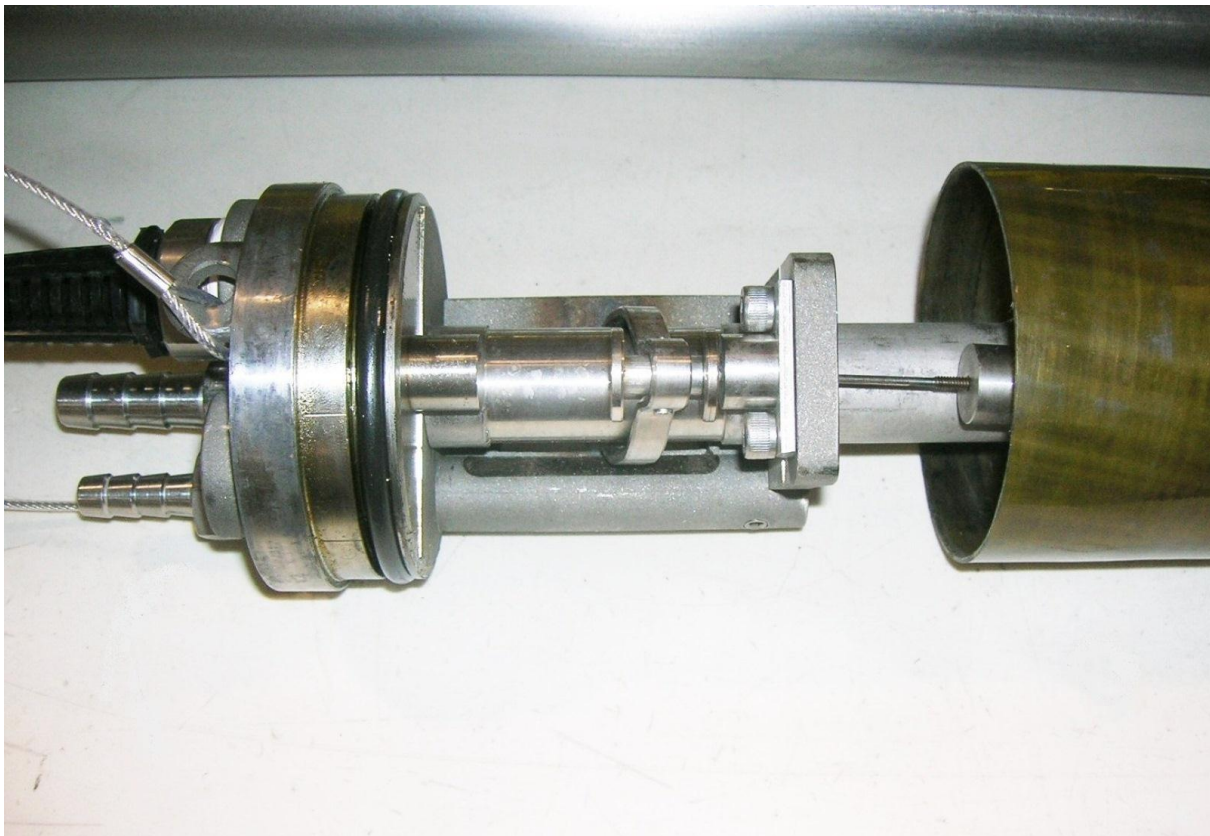

Figure 4-4

### **Verify and Adjust the Upper Gap Setting**

With the pump held vertically and the control rod in the up position (float up and upper magplate being held by the upper magnet, Figure 4-5), verify that the gap thickness is that of a sheet of paper. If not, use the following figures to make any needed adjustment to the upper gap.





Figure 4-5

Using a 1/2" wrench, loosen the lock nut on the upper valve. (The 1/2" wrench will need to be modified to access, loosen, and tighten the lock nut)

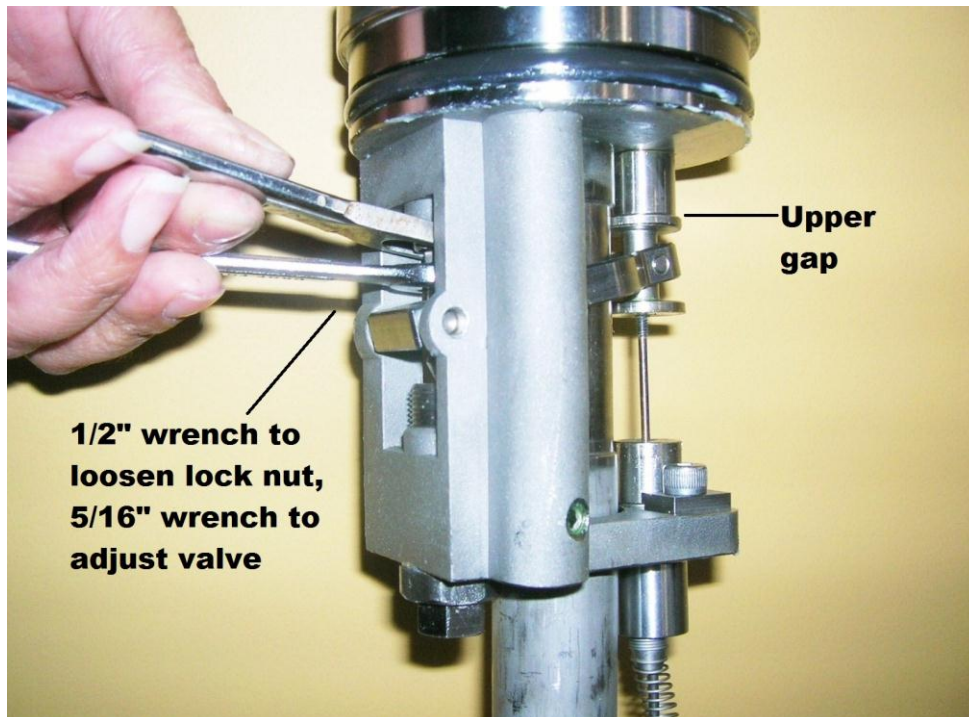

Figure 4-6



Using a 5/16" wrench, adjust the gap setting between the magplate and the magnet to the thickness of a sheet of paper.

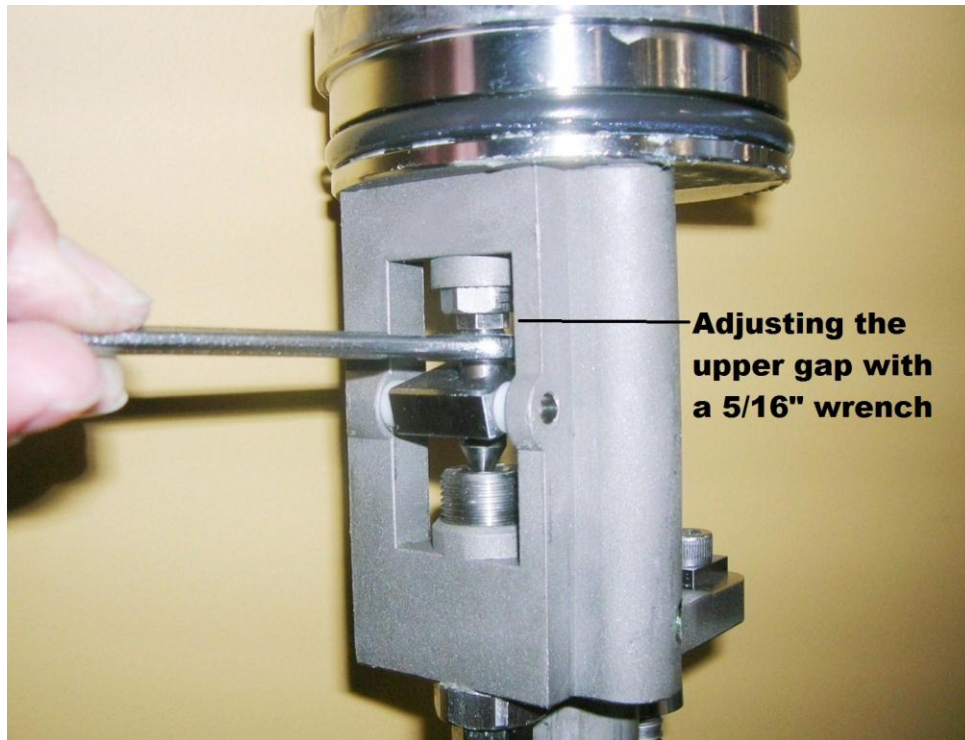

Figure 4-7



Figure 4-8

After setting the upper gap, use both wrenches to lock the valve in place. Hold the valve in place with the 5/16" wrench while tightening the lock nut with the 1/2" wrench. If you turn the lock nut by itself, it will turn the valve out of spec also.



Figure 4-9

This completes the upper gap setting.

### Verify and Adjust the Lower Gap Setting

If an adjustment to the lower valve is needed, loosen the lock nut to the lower valve using a  $\frac{3}{4}$ " and  $\frac{1}{2}$ " wrenches (Figure 4-10). Turn the lock nut out a few turns to keep it out of the way.

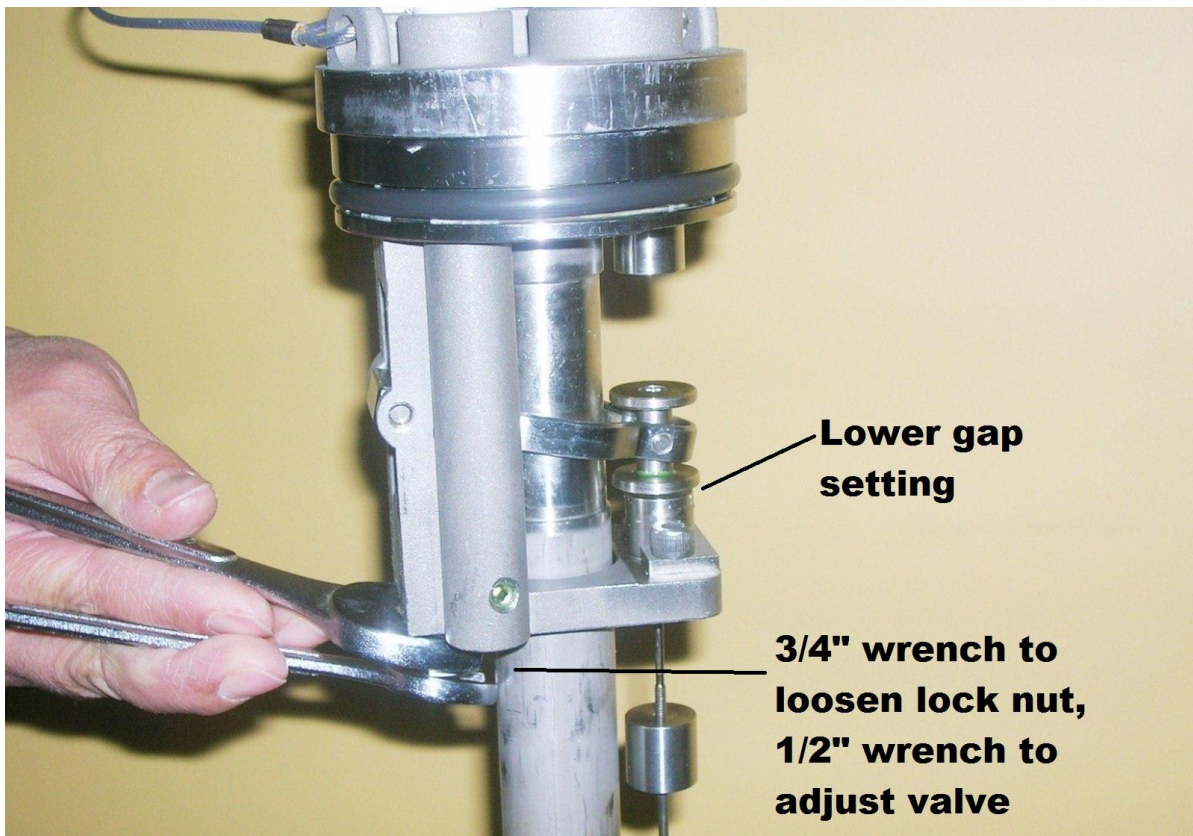

Figure 4-10

With the pump held vertically and the control rod and rocker arm in the down position, check the current gap between the lower magplate and the lower magnet. If closed or too far open (such as  $\frac{1}{8}$ " ), use the  $\frac{1}{2}$ " wrench and pre-set the gap to the thickness of a credit card before proceeding with the gap adjustment (Figure 4-11).



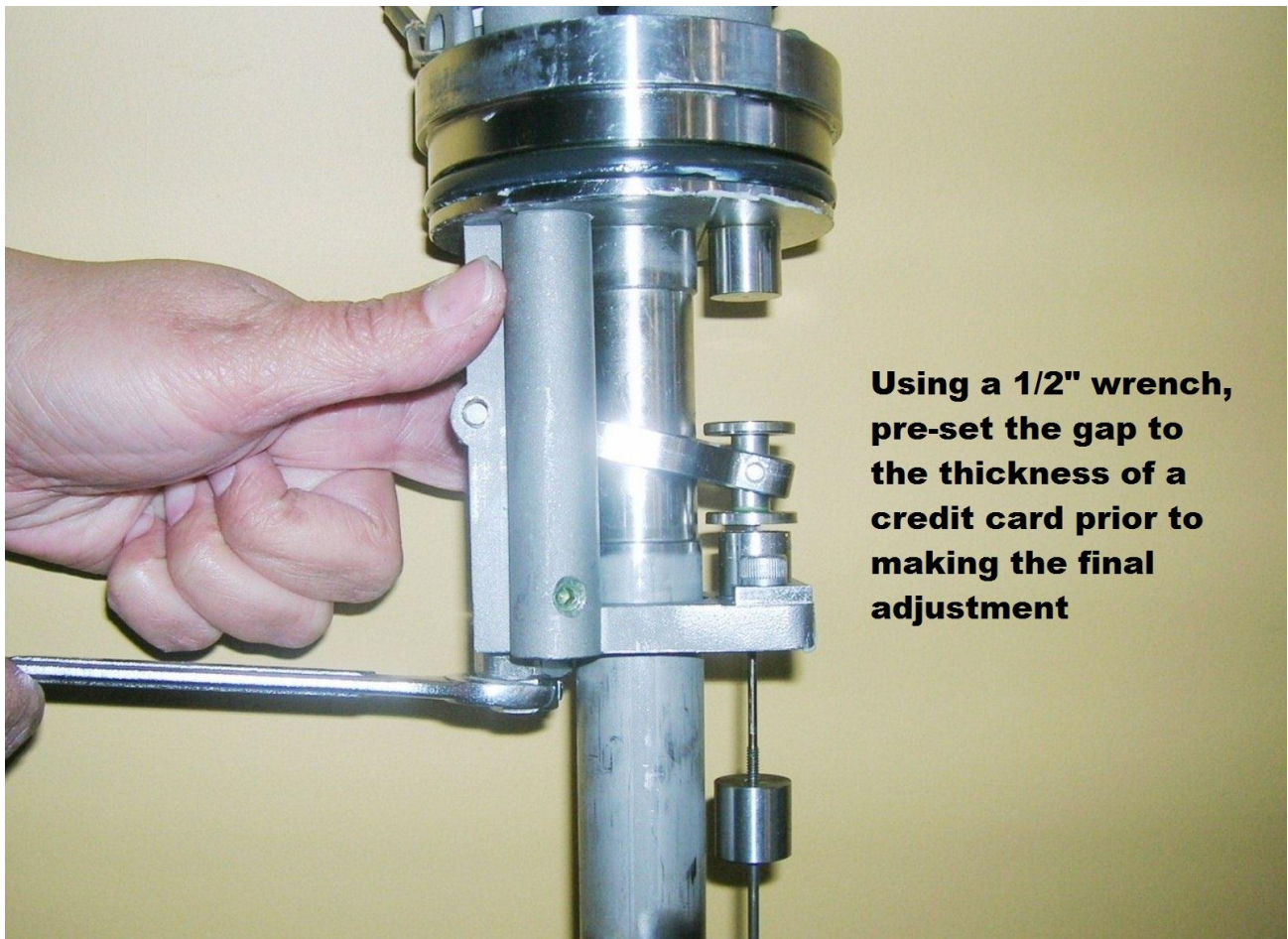

Figure 4-11

With the pump held vertically, raise the float to force the control rod to the up position (upper magplate being held by the upper magnet, Figure 4-5), with the control rod up, raise the float until the spring(s) just touches the bottom of the ballast (Figure 4-12).

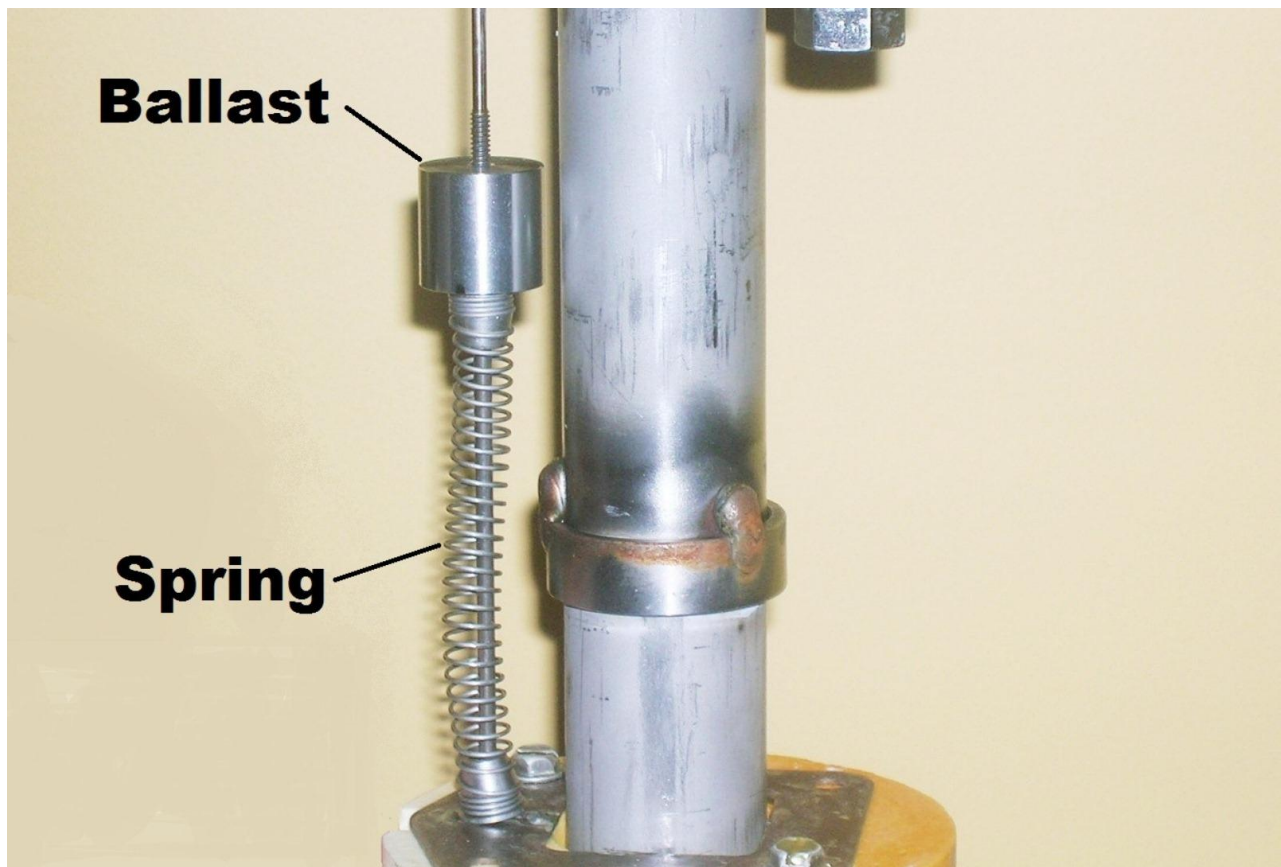

Figure 4-12

Next, raise the float a little more, slightly compressing the spring  $\frac{1}{4}$ " of its length ( $\frac{3}{4}$ " if two springs installed).



36" pumps come with one spring assembly above the float that is approximately 4" long, end to end, when new. Compress single spring units  $\frac{1}{4}$ ".  
48" and 60" pumps are built with two springs above the float (approximately 8" in length, end to end, when new). Compress double spring units  $\frac{3}{4}$ ".

Place a mark on the center pipe where the top of the float rests with this  $\frac{1}{4}$ " of compression (Figure 4-13), then let the float down, bringing the control rod down with it.

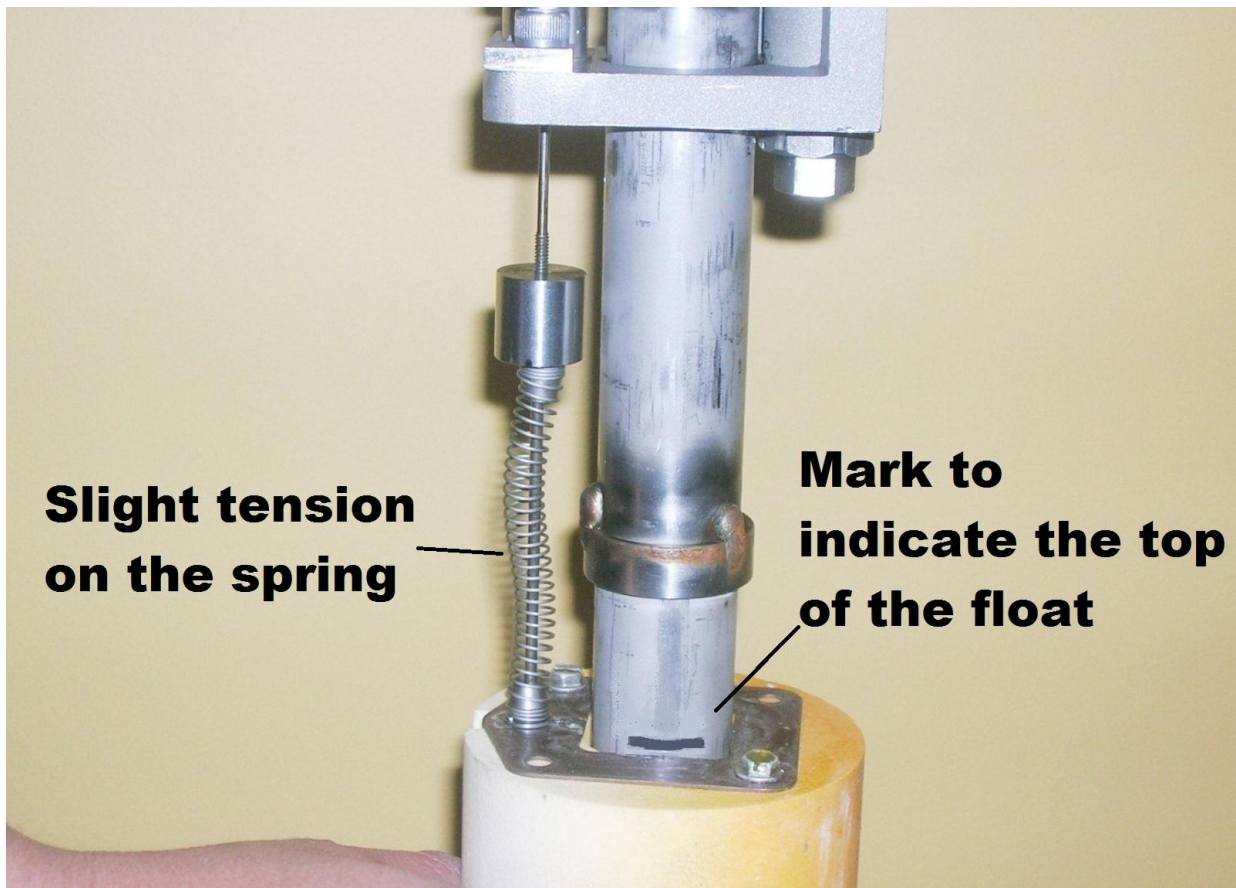

Figure 4-13

Make a second mark on the center pipe  $\frac{1}{4}$ " above the first mark to indicate the approximate point you want the rocker arm to shift up when the float rises (Figure 4-14).



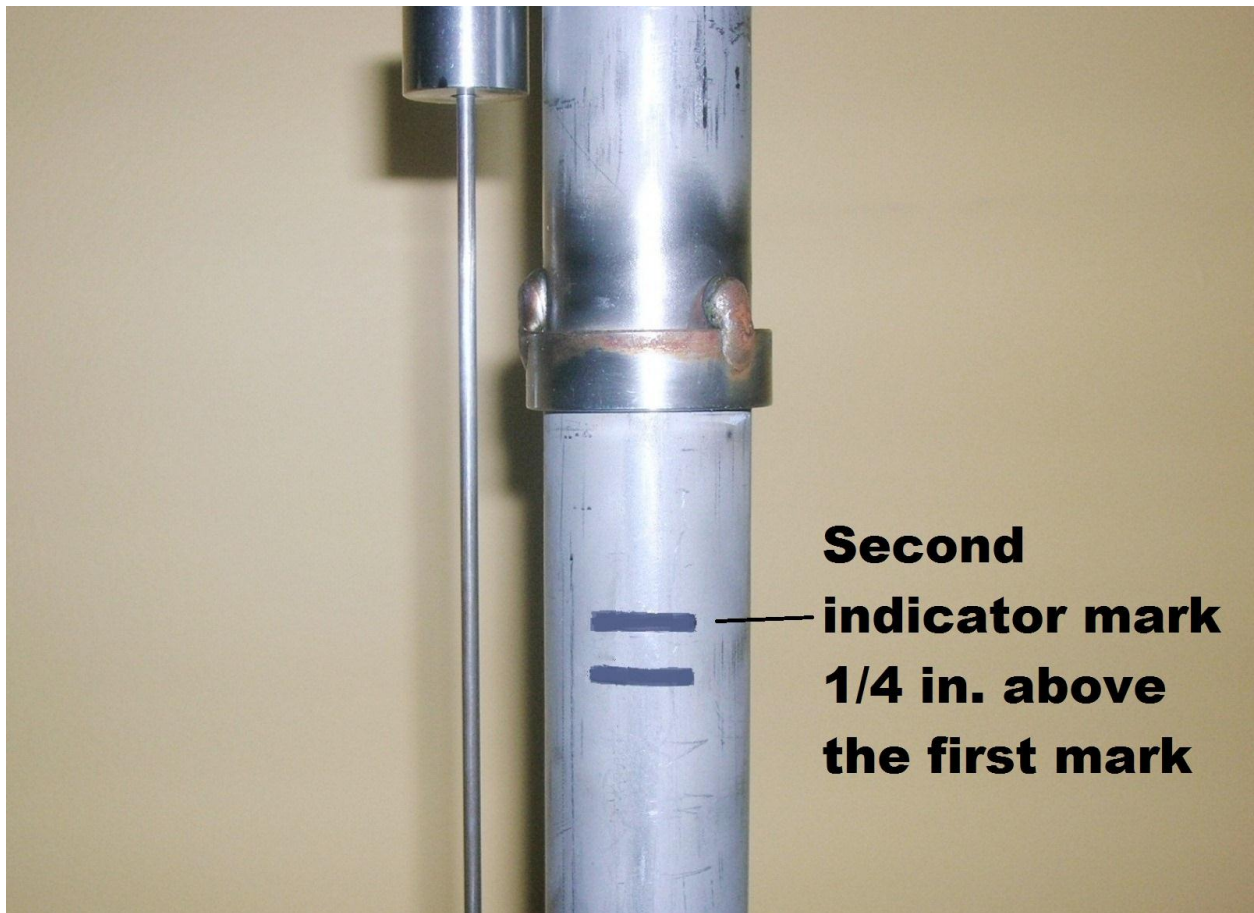

Figure 4-14

Lower the float to its resting position, allowing the control rod to be brought back down (Figure 4-15).

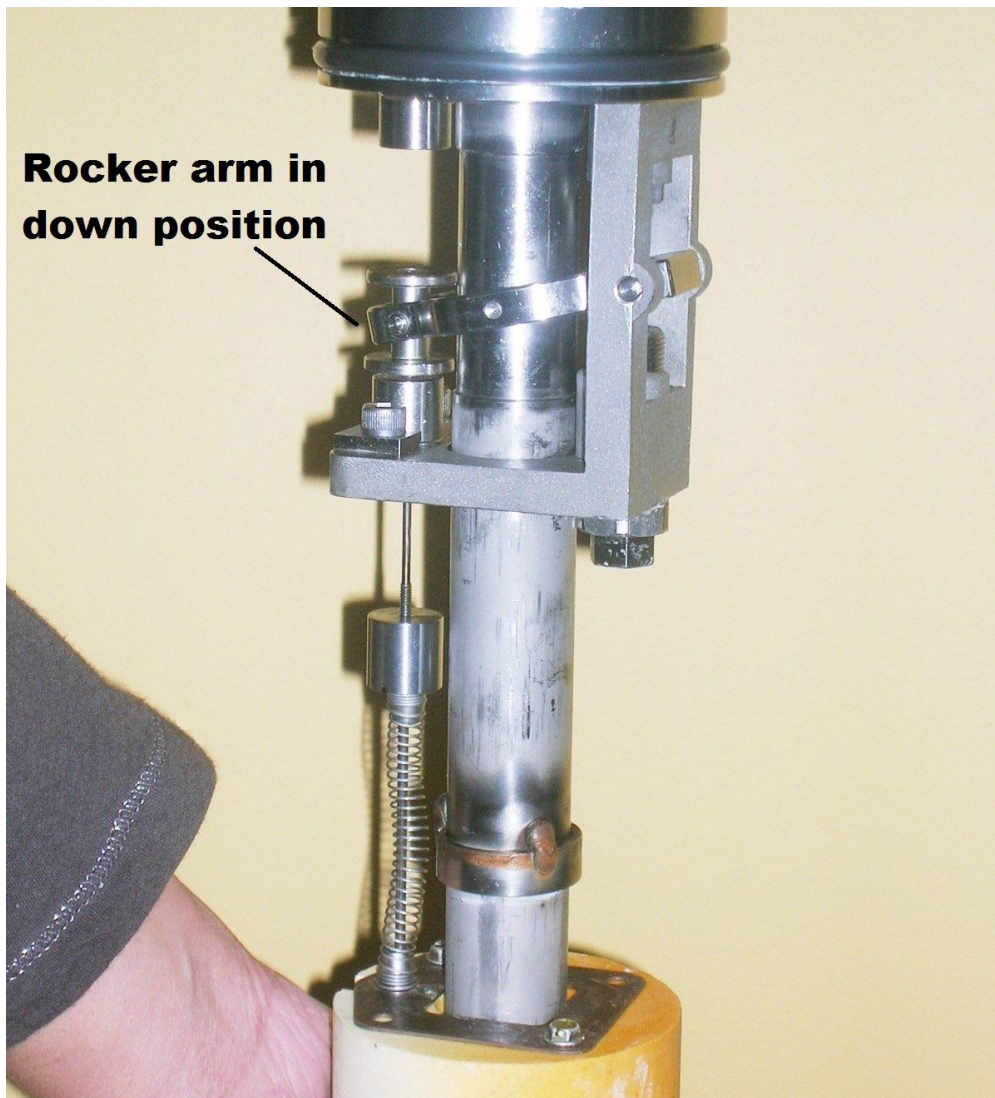

Figure 4-15

Raise the float up until the upper spring(s) just touches the bottom of the ballast, then continue to slowly raise the float, increasing the compression on the spring(s) against the ballast.

Watch the center pipe and note where the top of the float is when the control rod shifts up. The shift should occur when the top of the float is approximately at the upper of the two marks you made.



The shift of the rocker arm should also be a smooth and somewhat quick movement. If the rocker arm seems to be catching or stalling on something, verify that the rod hasn't been bent and that there is no debris in the hole of the lower magnet or blocking the movement of the rocker arm.

If the shift occurs early or late, the lower magnet gap will need to be further adjusted (closed or opened respectively). Use the 1/2" wrench to adjust the valve position in small increments. To decrease the gap, turn the valve counter-clockwise. To increase the gap, turn valve clockwise. Continue to lower and slowly raise the float each time to verify that the shift point happens at the second mark (Figure 4-16).



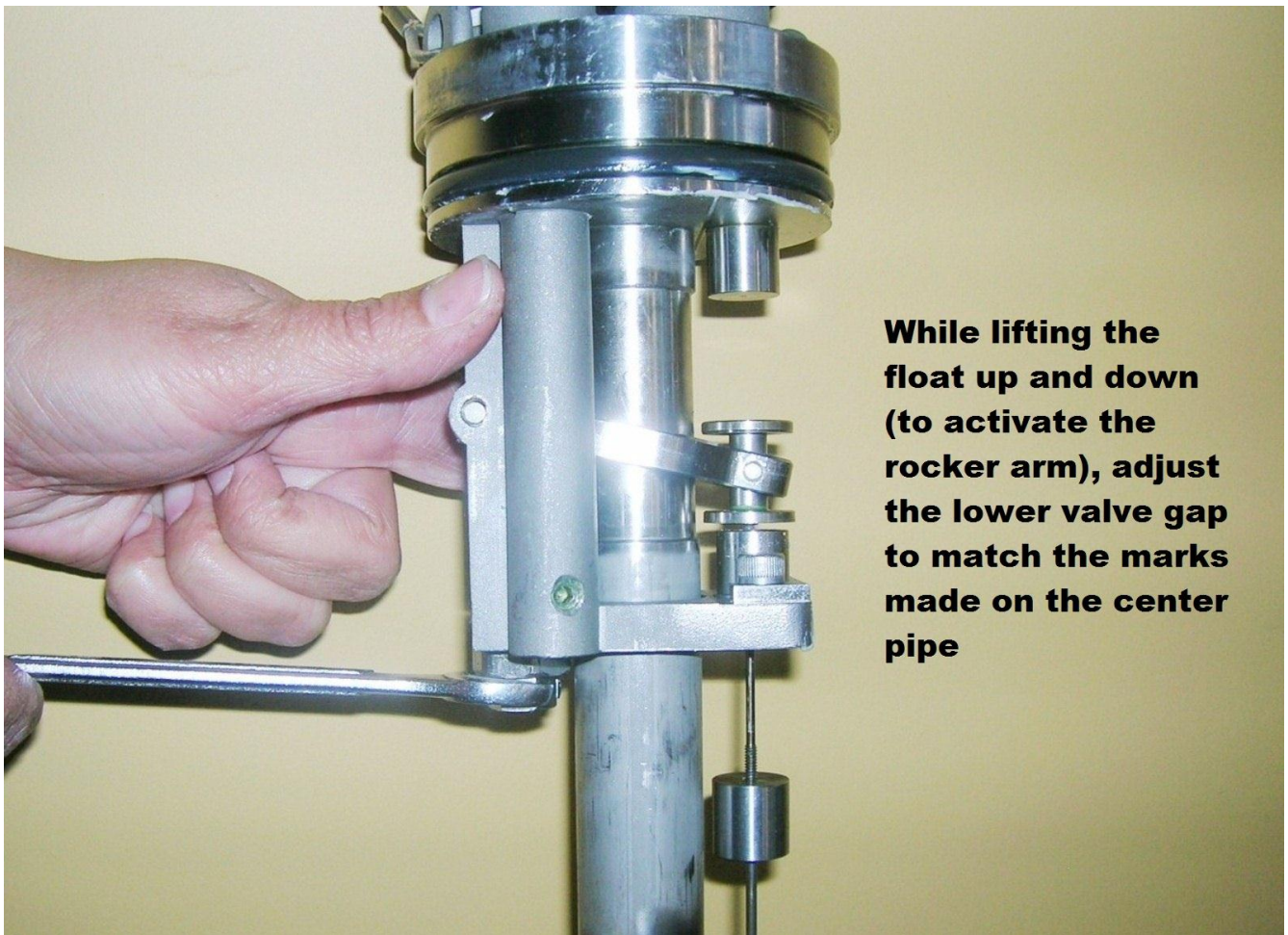

Figure 4-16

After setting the lower gap, use both wrenches to lock the valve in place. Hold the valve in place with the 1/2" wrench while tightening the lock nut with the 3/4" wrench. If you turn the lock nut by itself, it will turn the valve out of spec also.

The gaps indicated are approximations for a starting point. Minor adjustments during operation may have to be made for the reclaimer to shift properly.

## Section 5: System Troubleshooting

**Problem:** Pump does not discharge fluid to the surface.

**Solution:**

- Ensure the air pressure is adequate for the pump depth. (See the specifications section, minimum operating pressure example: .43 psi per ft. of static head pressure plus calculated head pressure loss of the piping/tubing).
- The bottom fluid intake screen is blocked – Clear the screen of all debris.
- The upper fluid intake screen is blocked – Clear the screen of all debris.
- The air exhaust vent hose is kinked or blocked – Clear the vent hose of all obstruction, replace if kinked.
- The Air In or Discharge hoses are kinked or cut – Inspect and replace damaged hoses.
- The lower gap is so close that the float cannot shift the rocker arm upward off the magnet – refer to Section 4 for rocker arm adjustment.
- A regular cleaning may be needed, especially in low activation pumps.

**Problem:** Too much air being injected into the discharged fluid.

**Solution:**

- Lower magplate gap is too narrow. Increase gap in very small increments.
- Air pressure set too high for depth.

**Problem:** Fluid shooting out of the vent tube.

**Solution:**

- Even though some “burping” is normal, the lower gap may be too wide. Decrease gap in very small increments.

When the pump housing is off, care must be taken to not bend the control rod (running the length of the pump) by gripping it with your hand, or allowing the rocker arm assembly to be bent should the pump fall against a hard surface.

If the pump continues to not work properly, contact your technical sales representative for assistance.

## Section 6: System Specifications

# 36" GEOTECH 3.5 AUTO-RECLAIMER

CONSTRUCTION MATERIALS	STAINLESS STEEL, TEFLON, VITON, HIGH DENSITY POLYETHYLENE, URETHANE	
HOUSING MATERIAL	FILAMENT WOUND FIBERGLASS REINFORCED EPOXY PIPE/STAINLESS STEEL.	
CONFIGURATION	36" DUAL (TOP/BOTTOM) LOADING FIXED INTAKE	36" BOTTOM LOADING FIXED INTAKE
PUMP TYPE	CONTROLLERLESS POSITIVE AIR DISPLACEMENT	
OUTSIDE DIAMETER	3.50 in. (8.89 cm.)	3.50 in. (8.89 cm.)
LENGTH	44.50 in. (113.0 cm.)	44.50 in. (113.0 cm.)
WEIGHT	15.9 lbs. (7.2 kg.)	15.9 lbs. (7.2 kg.)
MAX. RATED DEPTH	500 ft. (152.4 m.)	500 ft. (152.4 m.)
MIN. WELL ID	4.0 in. (10.2 cm.)	4.0 in. (10.2 cm.)
OPERATING PRESSURE RANGE	5-275 psi. (.3-18.9 bar)	
MIN. OPERATING PRESSURE	1 psi. (.07 bar) above static head	
AIR CONSUMPTION	< .75 scf. @ 45 psi. @ 40' depth of pump	
MIN. LIQUID DENSITY	.7 SpG (gr/cc)	
VOLUME/CYCLE	14.00 gpm. (53.0 lpm.) @ 20 ft.	.45 gal. (1.70 liters) 13.00 gpm. (49.21 lpm.) @ 20 ft.
MAXIMUM FLOW RATE	submergence @ 100 psi.	
MINIMUM ACTIVATION LEVEL	33.0 in. (83.8 cm.)	33.0 in. (83.8 cm.)
FITTINGS	STAINLESS STEEL (BARB TYPE)	
HOSE SIZES		
FLUID DISCHARGE	3/4 X 3/4 MPT	
AIR SUPPLY	3/8 X 3/8 MPT	
AIR EXHAUST	1/2 X 3/8 MPT	

### 36" Geotech 3.5 Auto-Reclaimer

All calculations based on Model GEO 3.50 w/Minimum 10' Submergence of pump head (based on water)

36" dual loading fixed intake (3/4" IF fluid discharge hose)

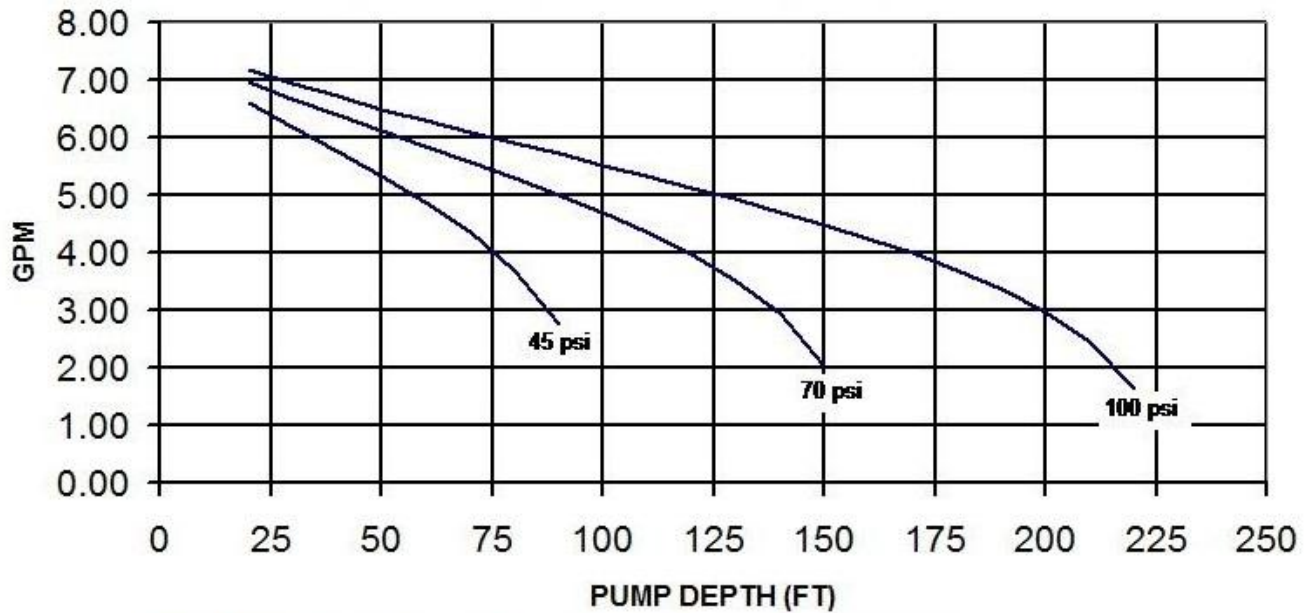

**Note: Specific gravity and viscosity will alter listed specifications.**

**36" Geotech 3.5 Auto-Reclaimer**

All calculations based on Model GEO 3.50 w/Minimum 10' Submergence of pump head (based on water)

36" dual loading fixed intake (3/4" IF fluid discharge hose)

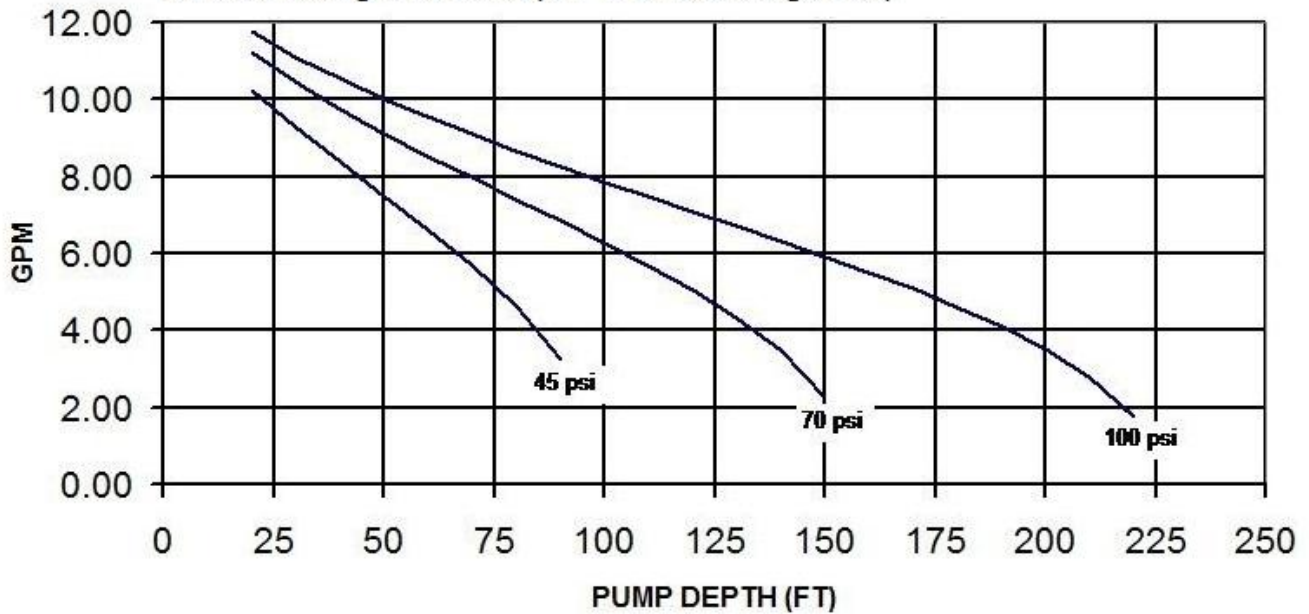

**Note: Specific gravity and viscosity will alter listed specifications.**

**36" Geotech 3.5 Auto-Reclaimer**

All calculations based on Model GEO 3.50 w/Minimum 10' Submergence of pump head (based on water)

36" dual loading fixed intake (3/4" IF fluid discharge hose)

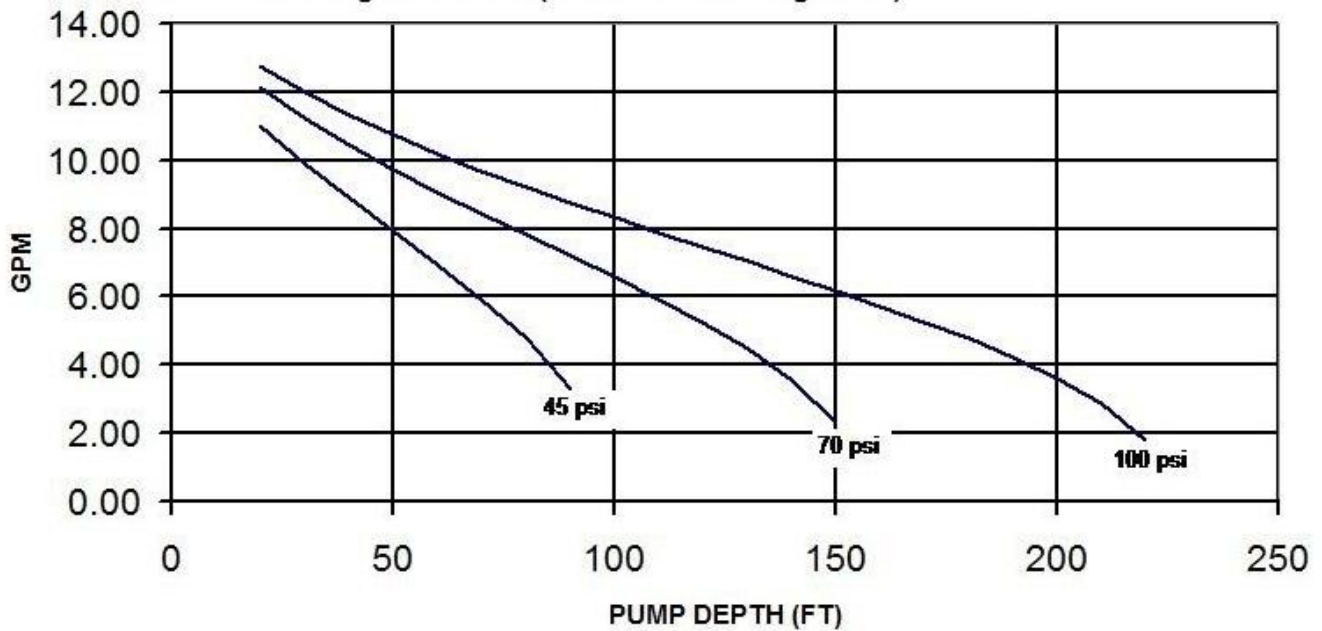

**Note: Specific gravity and viscosity will alter listed specifications.**



**36" GEOTECH 3.50 AUTO RECLAIMER  
AIR CONSUMPTION CURVES  
3/4" ID FLUID DISCHARGE HOSE**

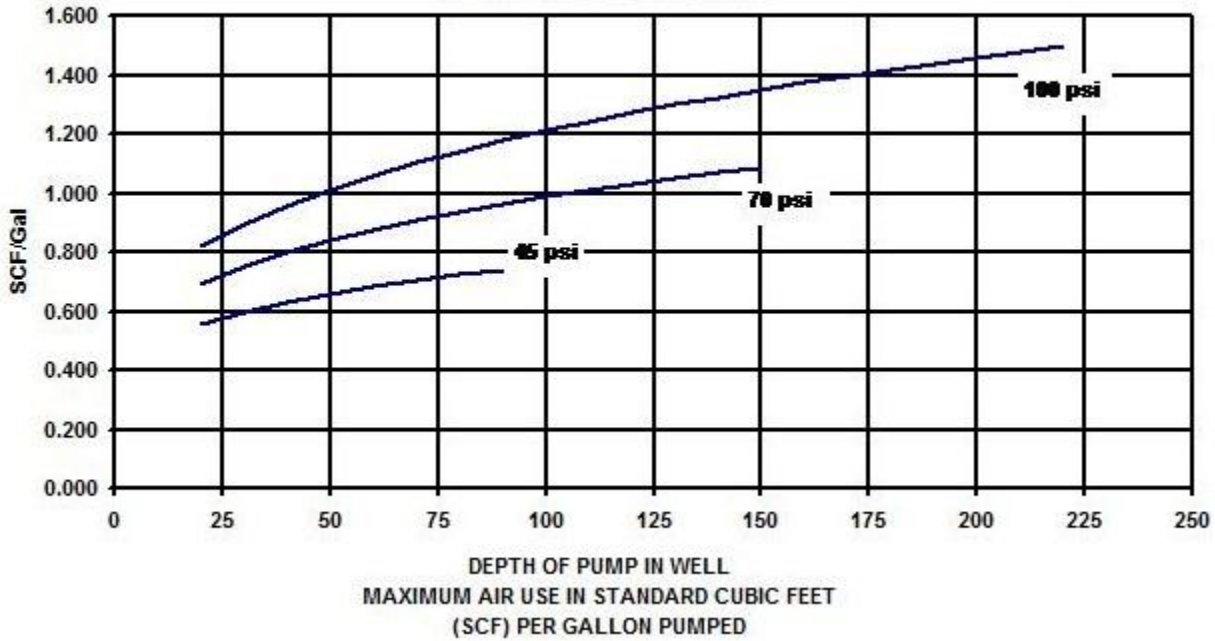

## 48" GEOTECH 3.5 AUTO-RECLAIMER

CONSTRUCTION MATERIALS	STAINLESS STEEL, TEFLON, VITON, HIGH DENSITY POLYETHYLENE, URETHANE	
HOUSING MATERIAL	FILAMENT WOUND FIBERGLASS REINFORCED EPOXY PIPE/STAINLESS STEEL.	
CONFIGURATION	48" DUAL (TOP/BOTTOM) LOADING FIXED INTAKE	48" BOTTOM LOADING FIXED INTAKE
PUMP TYPE	CONTROLLERLESS POSITIVE AIR DISPLACEMENT	CONTROLLERLESS POSITIVE AIR DISPLACEMENT
OUTSIDE DIAMETER	3.50 in. (8.89 cm.)	3.50 in. (8.89 cm.)
LENGTH	56.5 in. (143.5 cm.)	56.5 in. (143.5 cm.)
WEIGHT	18.0 lbs. (8.2 kg.)	18.0 lbs. (8.2 kg.)
MAX. RATED DEPTH	500 ft. (152.4 m.)	500 ft. (152.4 m.)
MIN. WELL ID	4.0 in. (10.2 cm.)	4.0 in. (10.2 cm.)
OPERATING PRESSURE RANGE	5–275 psi. (.3–18.9 bar)	
MIN. OPERATING PRESSURE	1 psi (.07 bar) above static head	
AIR CONSUMPTION	< .65 scf. @ 45 psi. @ 40' depth of pump	
MIN. LIQUID DENSITY	.7 SpG (gr/cc)	
VOLUME/CYCLE	14.50 gpm. (54.89 lpm.) @ 20 ft.	.75 gal. (2.84 liters)
MAXIMUM FLOW RATE	submergence @ 100 psi.	13.50 gpm. (51.10 lpm.) @ 20 ft.
MINIMUM ACTIVATION LEVEL	45.0 in. (114.0 cm.)	submergence @ 100 psi. 45.0 in. (114.0 cm.)
FITTINGS	STAINLESS STEEL (BARB TYPE)	
HOSE SIZES		
FLUID DISCHARGE	3/4 X 3/4 MPT	
AIR SUPPLY	3/8 X 3/8 MPT	
AIR EXHAUST	1/2 X 3/8 MPT	

**48" Geotech 3.5 Auto-Reclaimer**  
**All calculations based on Model GEO 3.50 w/Minimum 10' Submergence of pump head (based on water)**  
**48" dual loading fixed intake (3/4" IF fluid discharge hose)**

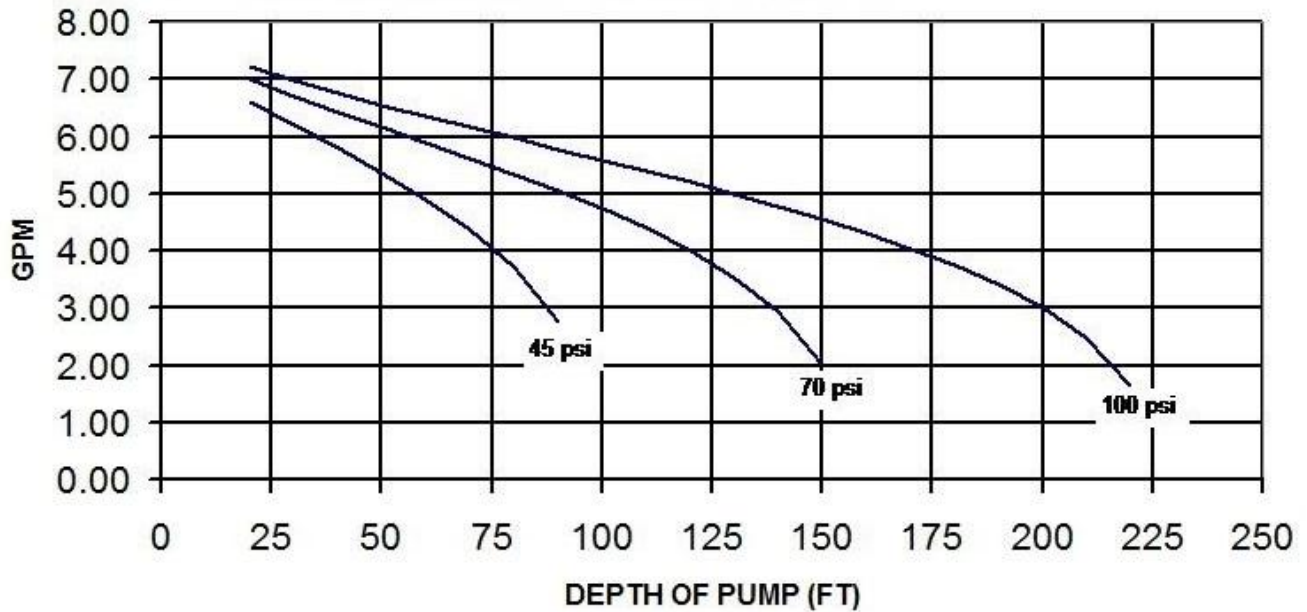

**Note: Specific gravity and viscosity will alter listed specifications.**

**48" Geotech 3.5 Auto-Reclaimer**  
**All calculations based on Model GEO 3.50 w/Minimum 10' Submergence of pump head (based on water)**  
**48" dual loading fixed intake (3/4" IF fluid discharge hose)**

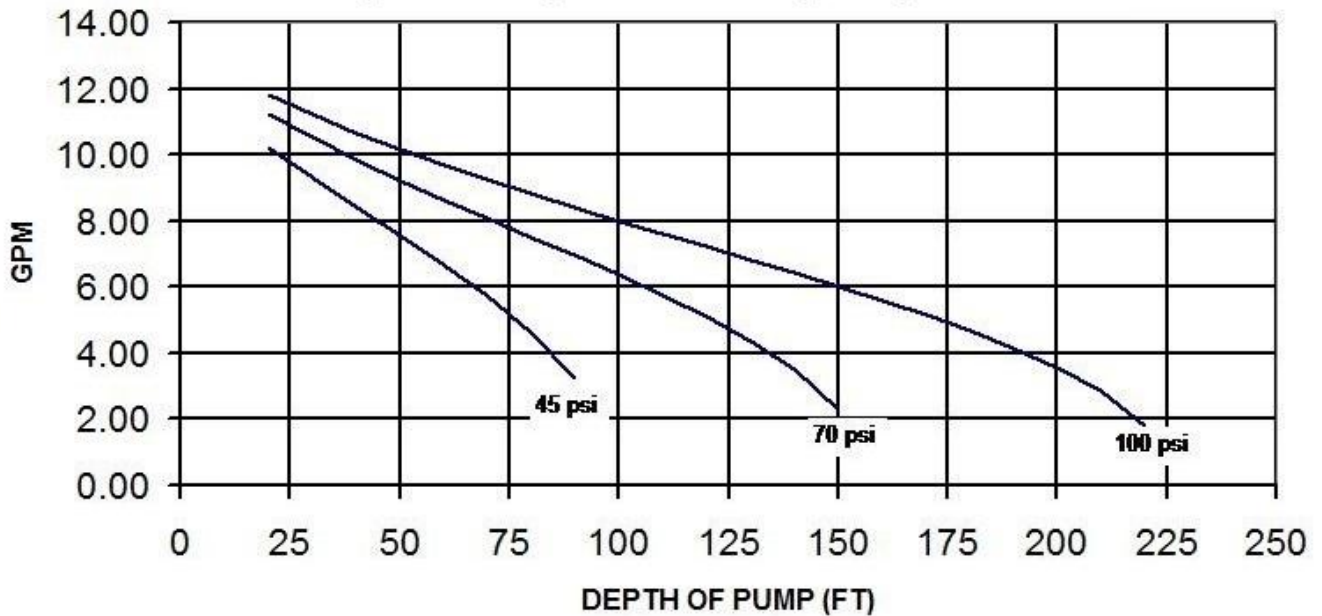

**Note: Specific gravity and viscosity will alter listed specifications.**

**48" Geotech 3.5 Auto-Reclaimer**

All calculations based on Model GEO 3.50 w/Minimum 10' Submergence of pump head (based on water)

48" dual loading fixed intake (3/4" IF fluid discharge hose)

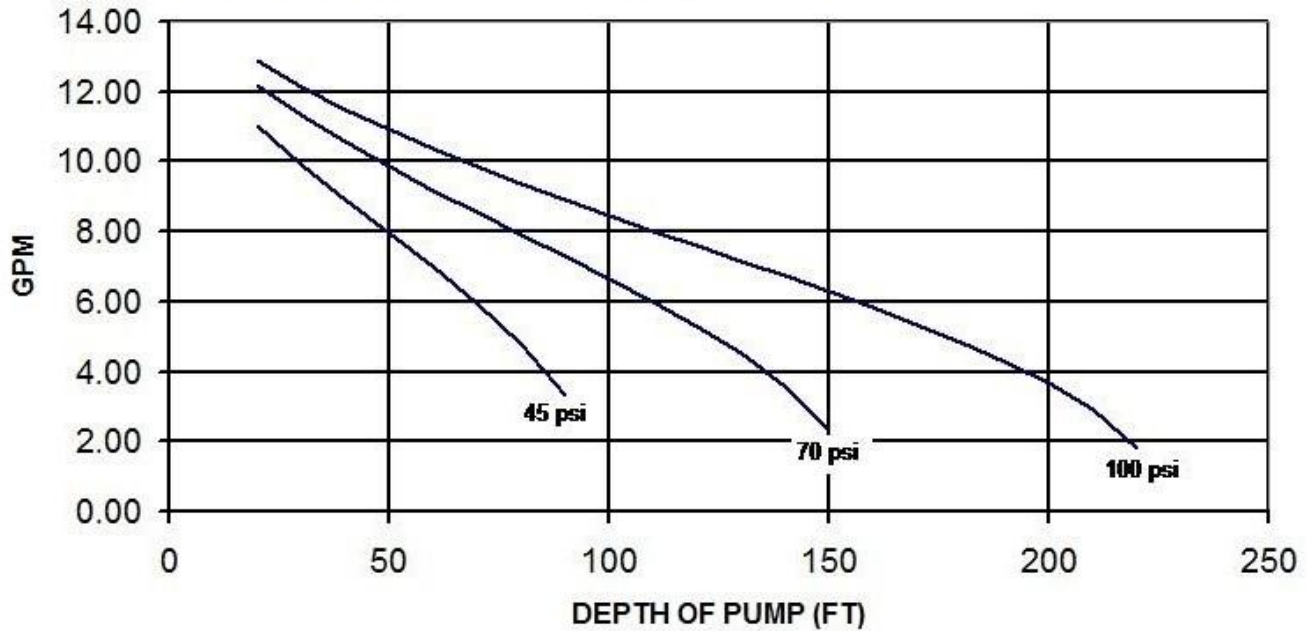

**Note: Specific gravity and viscosity will alter listed specifications.**

**48" GEOTECH 3.50 AUTO RECLAIMER  
AIR CONSUMPTION CURVES  
3/4" ID FLUID DISCHARGE HOSE**

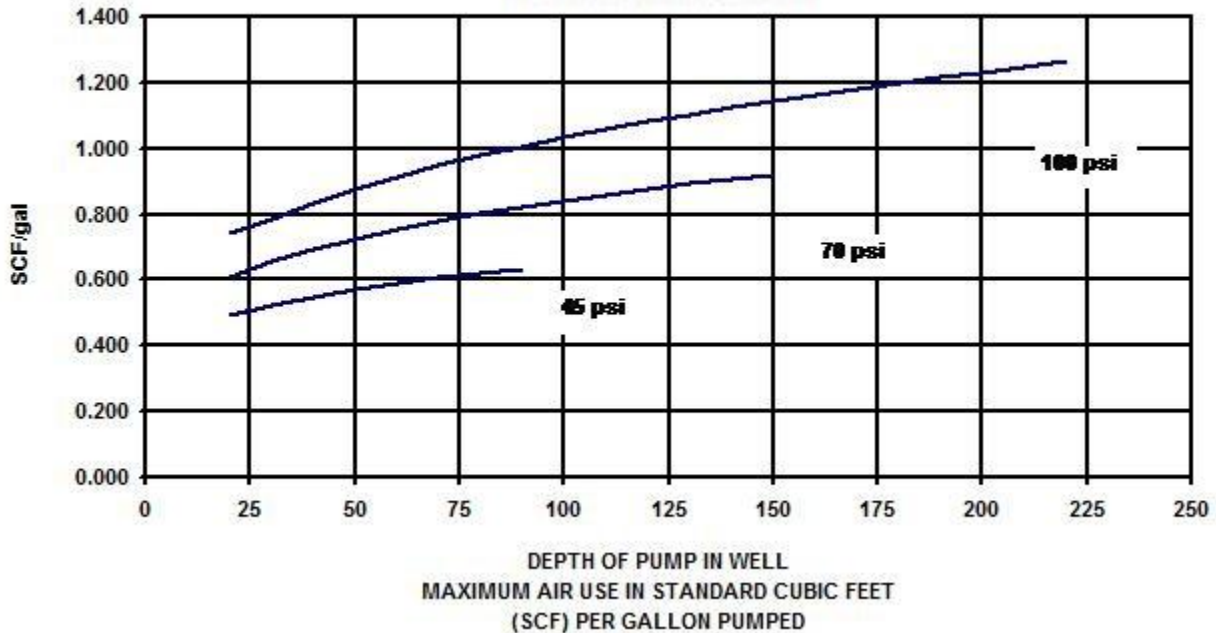

# 60" GEOTECH 3.5 AUTO-RECLAIMER

CONSTRUCTION MATERIALS	STAINLESS STEEL, TEFLON, VITON, HIGH DENSITY POLYETHYLENE, URETHANE	
HOUSING MATERIAL	FILAMENT WOUND FIBERGLASS REINFORCED EPOXY PIPE/STAINLESS STEEL	
CONFIGURATION	60" DUAL (TOP/BOTTOM) LOADING FIXED INTAKE	60" BOTTOM LOADING FIXED INTAKE
PUMP TYPE	CONTROLLERLESS POSITIVE AIR DISPLACEMENT	
OUTSIDE DIAMETER	3.50 in. (8.89 cm.)	3.50 in. (8.89 cm.)
LENGTH	68.5 in. (174.0 cm.)	68.5 in. (174.0 cm.)
WEIGHT	20.4 lbs. (9.3 kg.)	20.4 lbs. (9.3 kg.)
MAX. RATED DEPTH	500 ft. (152.4 m.)	500 ft. (152.4 m.)
MIN. WELL ID	4.0 in. (10.2 cm.)	4.0 in. (10.2 cm.)
OPERATING PRESSURE RANGE	5-275 psi. (.3-18.9 bar)	
MIN. OPERATING PRESSURE	1 psi (.07 bar) above static head	
AIR CONSUMPTION	< .60 scf. @ 45 psi. @ 40' depth of pump	
MIN. LIQUID DENSITY	.7 SpG (gr/cc)	
VOLUME/CYCLE	15.00 gpm. (56.78 lpm.) @ 20 ft.	1.05 gal. (3.97 liters)
MAXIMUM FLOW RATE	submergence @ 100 psi.	14.00 gpm. (53.0 lpm.) @ 20 ft. submergence @ 100 psi.
MINIMUM ACTIVATION LEVEL	57.0 in. (145.0 cm.)	57.0 in. (145.0 cm.)
FITTINGS	STAINLESS STEEL (BARB TYPE)	
HOSE SIZES		
FLUID DISCHARGE	3/4 X 3/4 MPT	
AIR SUPPLY	3/8 X 3/8 MPT	
AIR EXHAUST	1/2 X 3/8 MPT	

## 60" Geotech 3.5 Auto-Reclaimer

All calculations based on Model GEO 3.50 w/Minimum 10' Submergence of pump head (based on water)

60" dual loading fixed intake (3/4" IF fluid discharge hose)

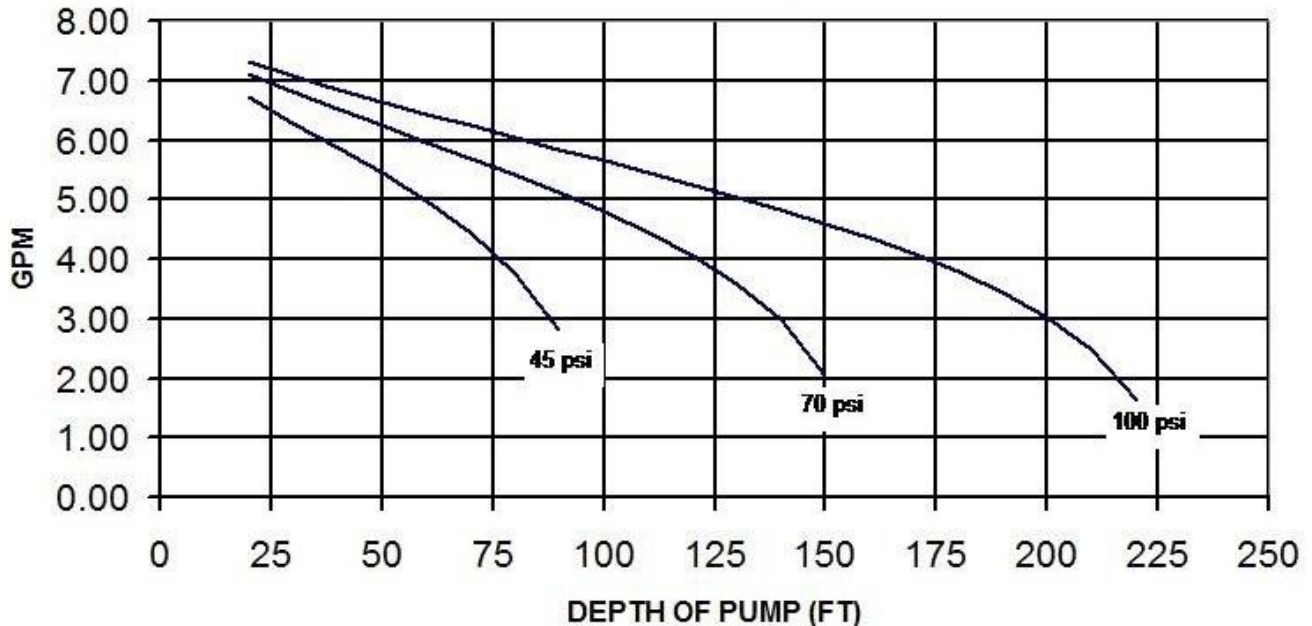

Note: Specific gravity and viscosity will alter listed specifications.



**60" Geotech 3.5 Auto-Reclaimer**

All calculations based on Model GEO 3.50 w/Minimum 10' Submergence of pump head (based on water)

60" dual loading fixed intake (3/4" IF fluid discharge hose)

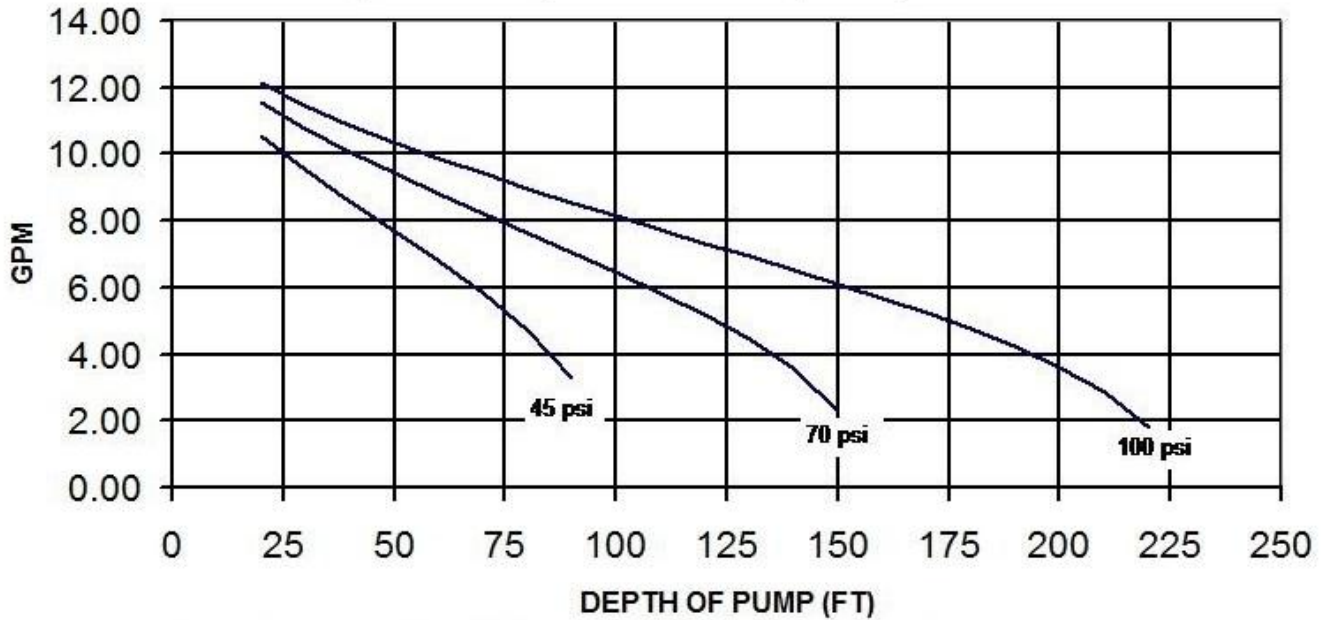

**Note: Specific gravity and viscosity will alter listed specifications.**

**60" Geotech 3.5 Auto-Reclaimer**

All calculations based on Model GEO 3.50 w/Minimum 10' Submergence of pump head (based on water)

60" dual loading fixed intake (3/4" IF fluid discharge hose)

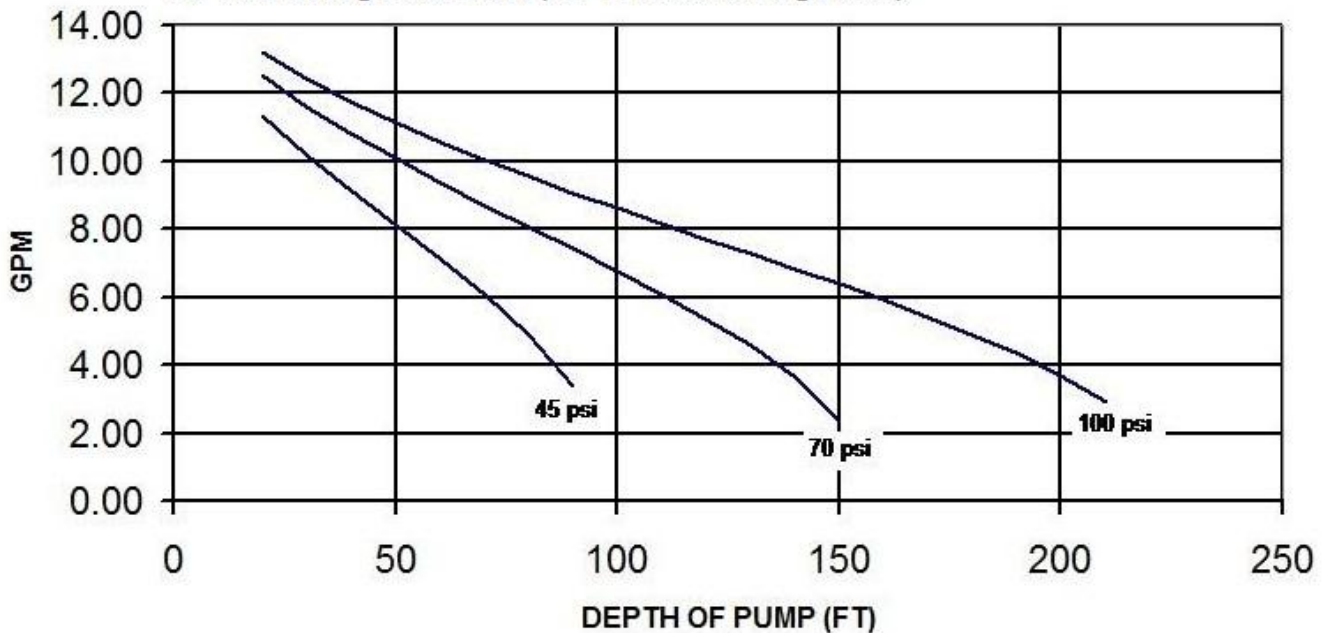

**Note: Specific gravity and viscosity will alter listed specifications.**

60" GEOTECH 3.50 AUTO-RECLAIMER  
AIR CONSUMPTION CURVES  
3/4" ID FLUID DISCHARGE HOSE

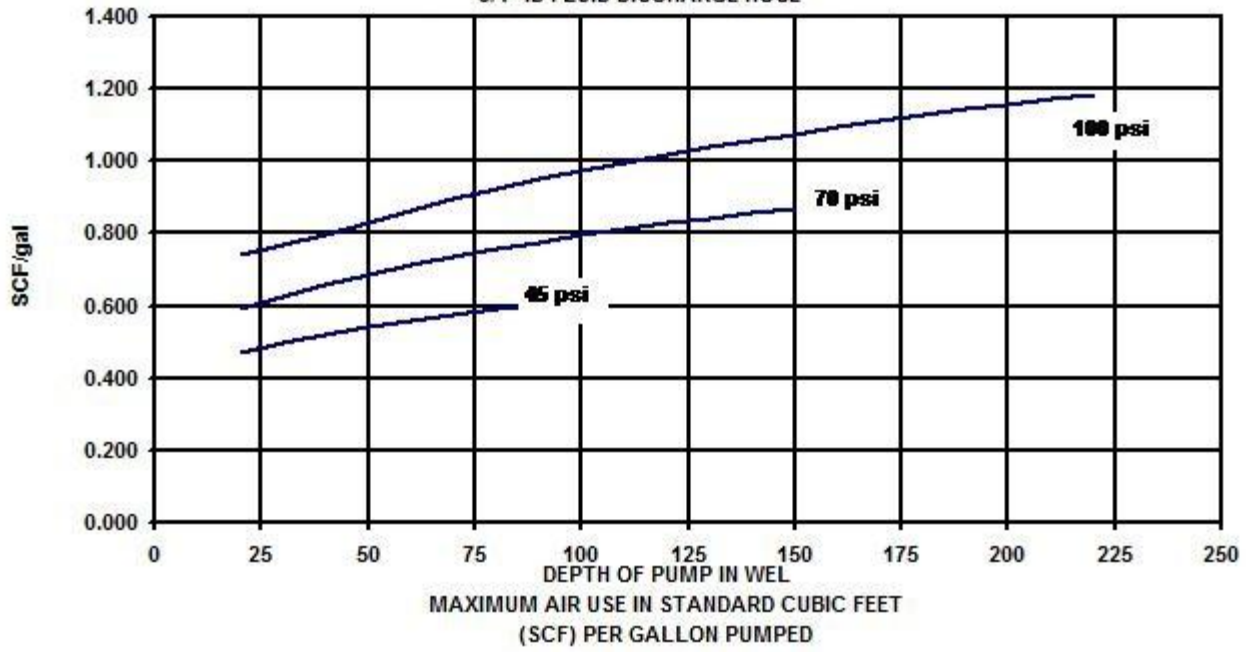

## Section 7: System Schematics

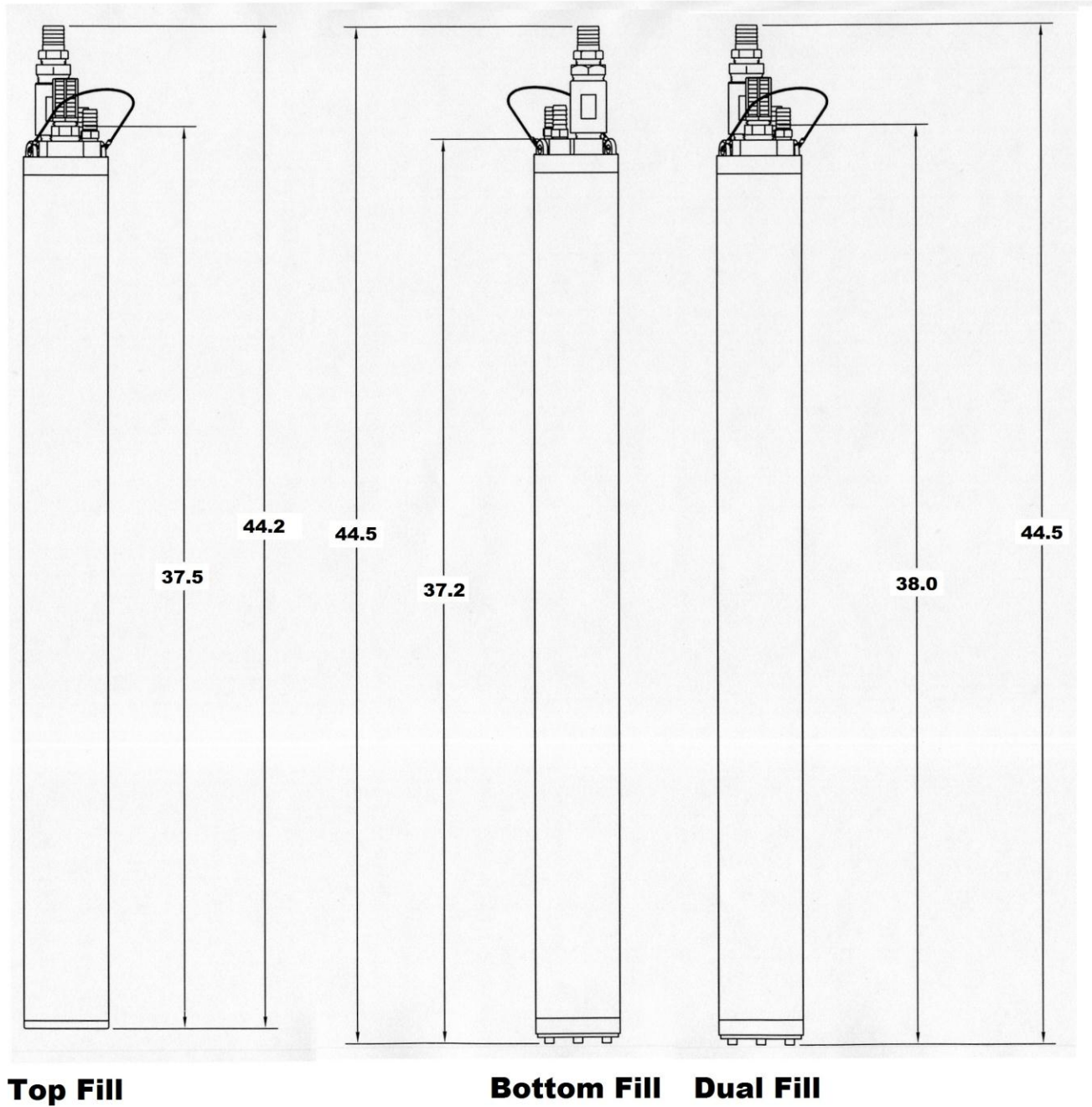
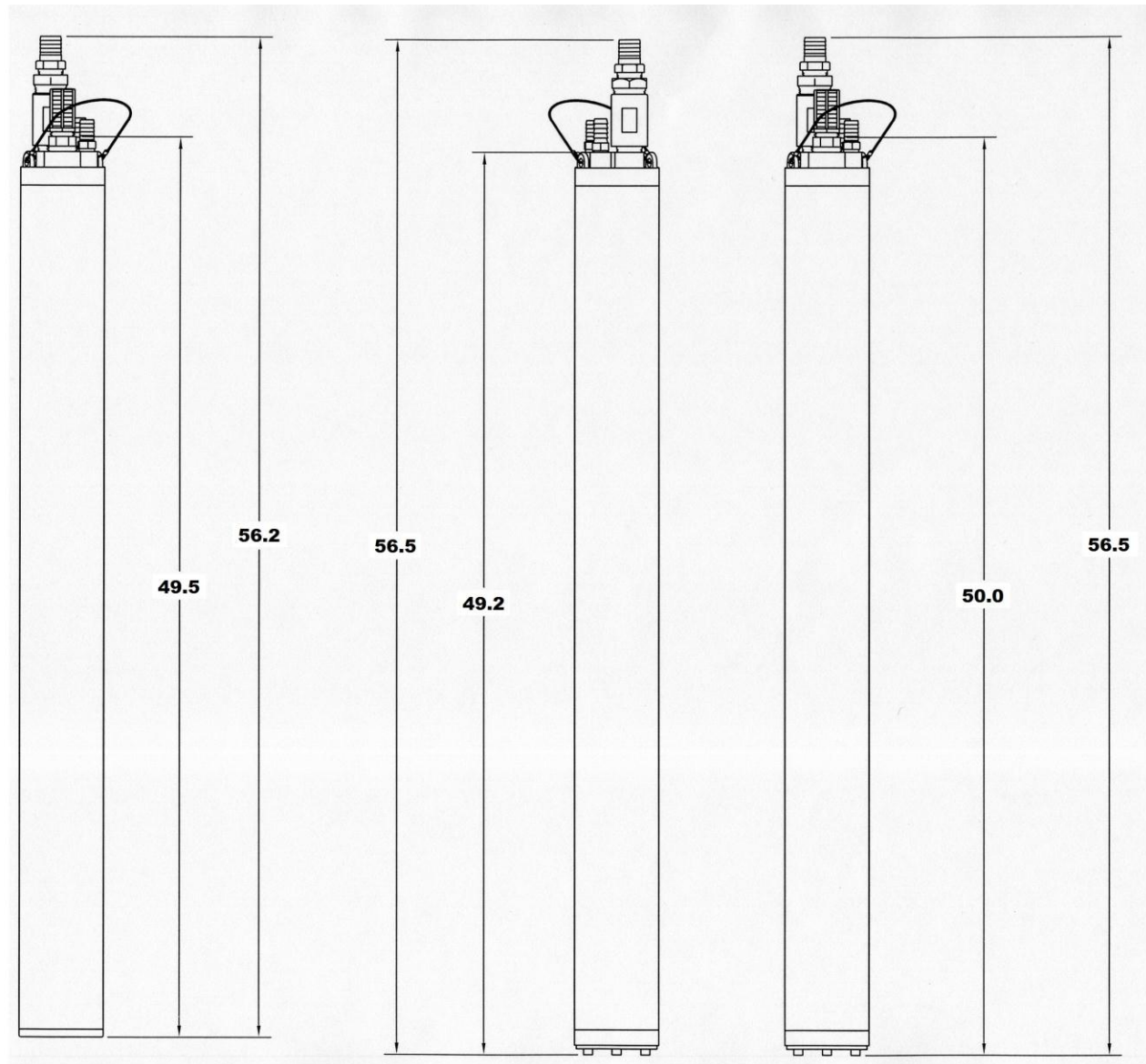

Figure 7-1 36" Auto-Reclaimer models and dimensions



**Top Fill**

**Bottom Fill**

**Dual Fill**

Figure 7-2 48" Auto-Reclaimer models and dimensions

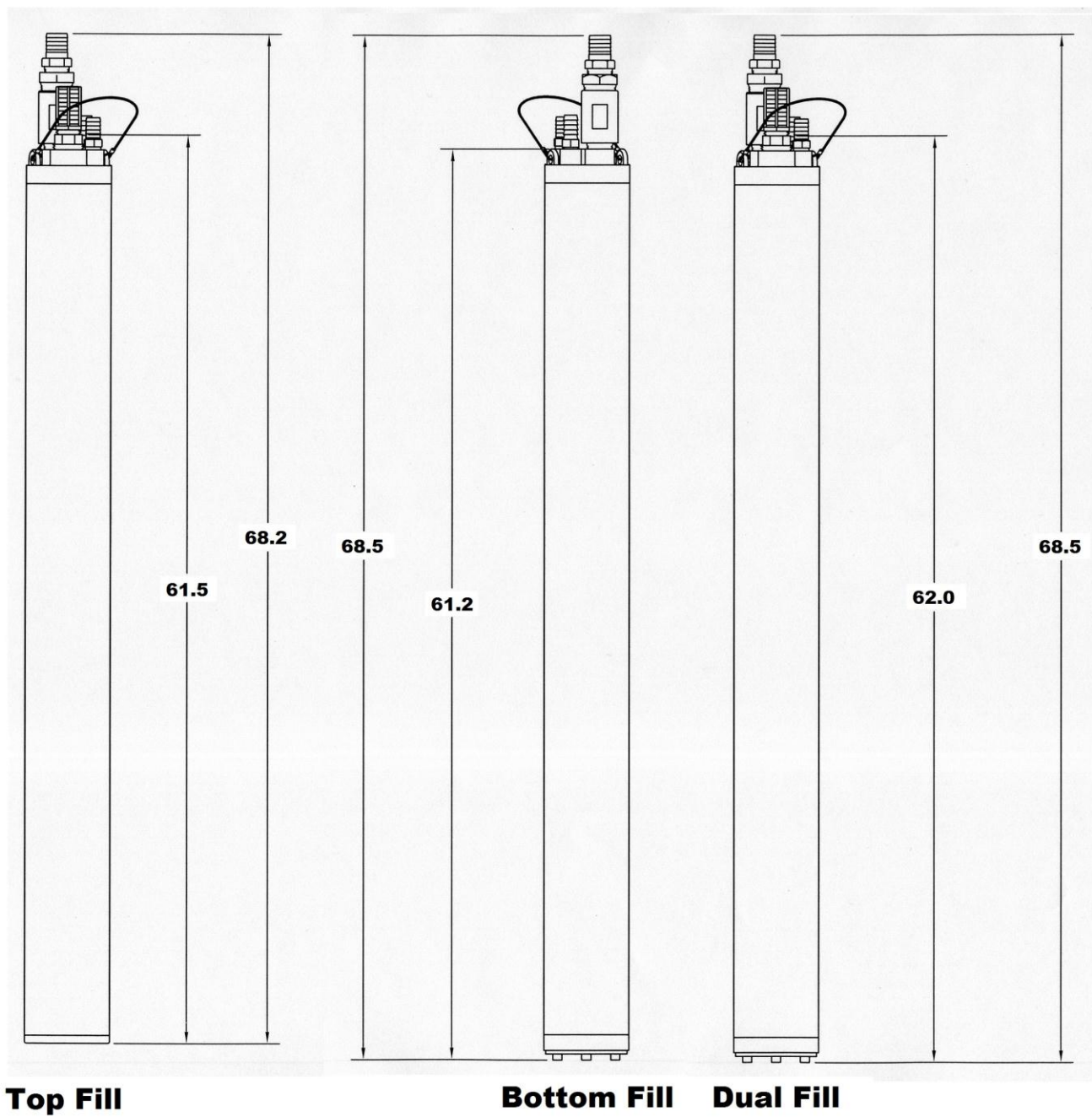

Figure 7-3 60" Auto-Reclaimer models and dimensions

## Section 8: Replacement Parts List

Parts List	Parts Description
16600211	Screen, Intake, PVC, 3.5 Auto (Fluid-in)
26600152	Bushing, SS4, Intake, 3.5 (Fluid-in)
16600098	Ball, PTFE, 7/8" (Fluid-in)
16600218	Hosebarb, SS6, 3/4" X 3/4" MPT (Discharge)
PPP012052	Bushing, SS4, 1" x .75" (Discharge)
26600196	Bushing, SS4, Orbital, Disch 3.5 (Discharge)
17500207	Ball, SS, 7/8" (Discharge)
26600169	Body, SS4, Discharge, 3.5 Auto
16600217	Hosebarb, SS6, 1/2" X 3/8" MPT (Vent)
16600213	Hosebarb, SS6, 3/8" X 3/8" MPT (Air-in)
26600039	Bottom Inlet, SS, 3.5 (Bottom Fill)
26600040	Cap, Bottom Inlet, 3.5 (Bottom Fill)
17500315	Ball, TFE, 1.5"
26600046	Lower Valve, SS, 3.5 Auto
26600047	Upper Valve, SS, 3.5 Auto
16600166	Screw, SS8, 1/4-20 X 3/8", SHCS
26600151	Spring Guide, DEL, Female, 3.5 Auto
16600215	Spring, SS6, Upper, Cmprsn, 3.5 Auto
16600216	Spring, SS6, Lower, Cmprsn, 3.5 Auto
26600097	Rod, Control, H900, 3.5 Auto 36"
26600030	Rod, Control, H900, 3.5 Auto 48"
26600096	Rod, Control, H900, 3.5 Auto 60"
56600020	Assy, Float, 3.5 Autoreclaimer
17500516	O-ring, Viton, #336, Shore75A (Housing)
17500516	O-ring, Viton, #336, Shore75A (Housing)
26600131	Screen, Inlet, SS, 3.5, Flat
26600049	Screen, Inlet, SS, 3.5 x 3"
26600146	Screen, Inlet, SS, 3.5 x 12"
26600099	Pipe, Center, SS4, 3/4" X 36", 3.5AR
26600031	Pipe, Center, SS4, 3/4" X 48", 3.5AR
26600098	Pipe, Center, SS4, 3/4" X 60", 3.5AR
56600032	Housing, 3.5 AR/Reclaimer, 36"
56600030	Housing, 3.5 AR/Reclaimer, 48"
56600031	Housing, 3.5 Autoreclaimer, 60"
(Autoreclaimer housings are also available in stainless steel)	
86600039	Pneumatic Counter, 3.5 Autoreclaimer
16600115	Manual, Autoreclaimer, 3.5"

Do not see your part? Then please contact Geotech Sales for more information on available parts and accessories. Ask about our extensive line of tubing and hose.

## NOTES

## NOTES



## NOTES

## The Warranty

For a period of one (1) year from date of first sale, product is warranted to be free from defects in materials and workmanship. Geotech agrees to repair or replace, at Geotech's option, the portion proving defective, or at our option to refund the purchase price thereof. Geotech will have no warranty obligation if the product is subjected to abnormal operating conditions, accident, abuse, misuse, unauthorized modification, alteration, repair, or replacement of wear parts. User assumes all other risk, if any, including the risk of injury, loss, or damage, direct or consequential, arising out of the use, misuse, or inability to use this product. User agrees to use, maintain and install product in accordance with recommendations and instructions. User is responsible for transportation charges connected to the repair or replacement of product under this warranty.

## Equipment Return Policy

A Return Material Authorization number (RMA #) is required prior to return of any equipment to our facilities, please call our 800 number for appropriate location. An RMA # will be issued upon receipt of your request to return equipment, which should include reasons for the return. Your return shipment to us must have this RMA # clearly marked on the outside of the package. Proof of date of purchase is required for processing of all warranty requests.

This policy applies to both equipment sales and repair orders.

FOR A RETURN MATERIAL AUTHORIZATION, PLEASE CALL OUR  
SERVICE DEPARTMENT AT 1-800-833-7958.

Model Number: \_\_\_\_\_

Serial Number: \_\_\_\_\_

Date of Purchase: \_\_\_\_\_

## Equipment Decontamination

Prior to return, all equipment must be thoroughly cleaned and decontaminated. Please make note on RMA form, the use of equipment, contaminants equipment was exposed to, and decontamination solutions/methods used. Geotech reserves the right to refuse any equipment not properly decontaminated. Geotech may also choose to decontaminate the equipment for a fee, which will be applied to the repair order invoice.



**Geotech Environmental Equipment, Inc**  
2650 East 40th Avenue Denver, Colorado 80205  
(303) 320-4764 • **(800) 833-7958** • FAX (303) 322-7242  
email: [sales@geotechenv.com](mailto:sales@geotechenv.com) website: [www.geotechenv.com](http://www.geotechenv.com)