



Enviro-Equipment Inc.
Remediation Division
10120 Industrial Drive
Pineville NC 28134

Stock # 1798

**Used, OSF-4, Pan America 10-GPM Fiberglass Gravity Feed Oil Water Separator
with Product Storage Compartment and Sludge Hopper.**

The OSF-4 Oil Water Separator places a volume of corrugated Flopak coalescing media into the waste stream, the tank's flow path brings the oils and solids bearing water to the influent end of the plate pack, it flows horizontally through the pack where oils then encounter the plate surface and are effectively separated from the water, the oil droplets roll up the plate surface begin to coalesce into larger droplets. Then, the larger droplets increased buoyancy pulls the oils away from the surface rising to the water surface. Solids perform the reverse and drop into the sludge hopper bottom.



Web Site: www.enviroequipment.com
Email: remediation@enviroequipment.com

Toll Free: 1-866-655-8287
Local: 704-566-7723



Enviro-Equipment Inc.
Remediation Division
10120 Industrial Drive
Pineville NC 28134

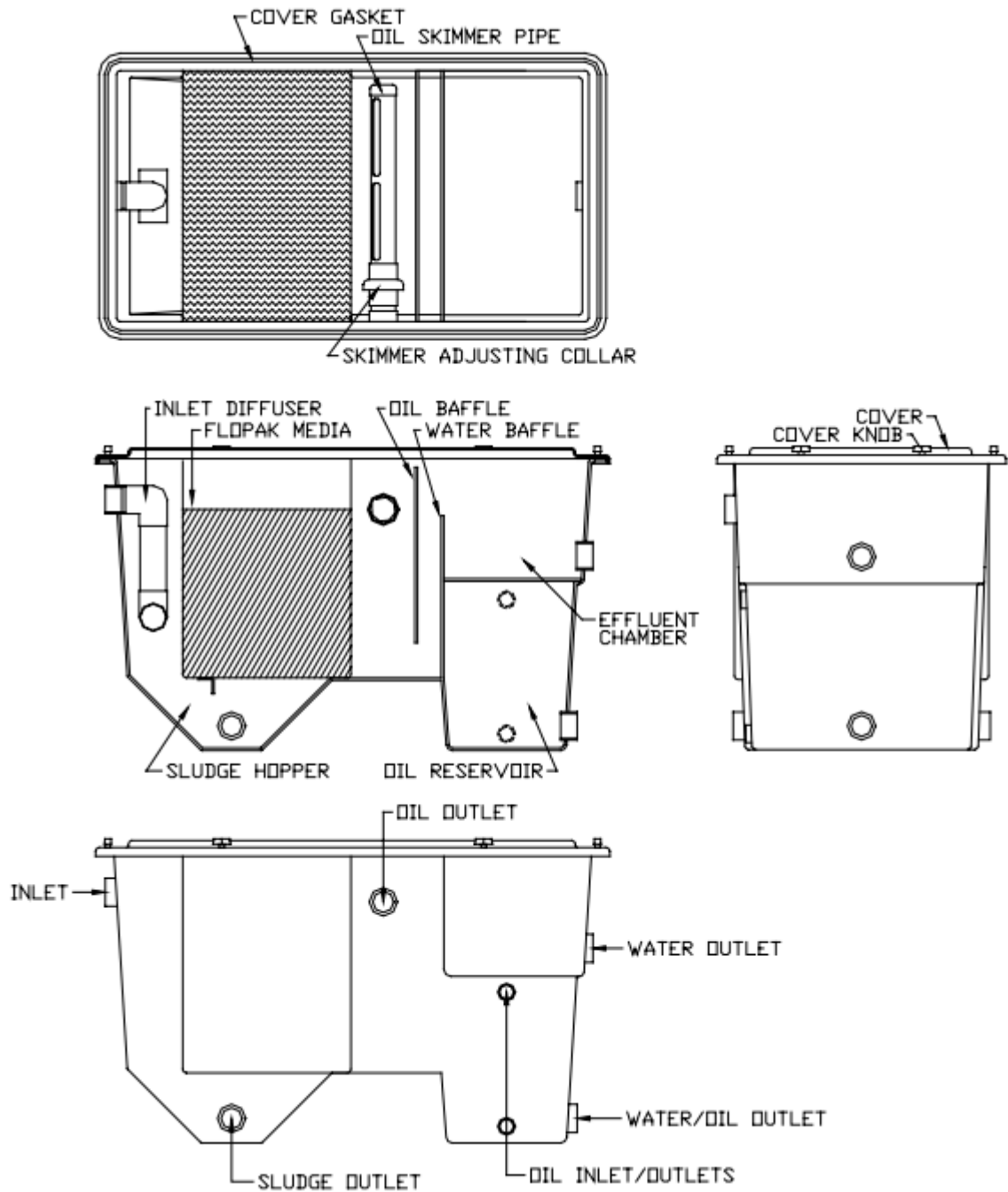

2-inch Inlet and Outlet FMPT.



Enviro-Equipment Inc.
Remediation Division
 10120 Industrial Drive
 Pineville NC 28134

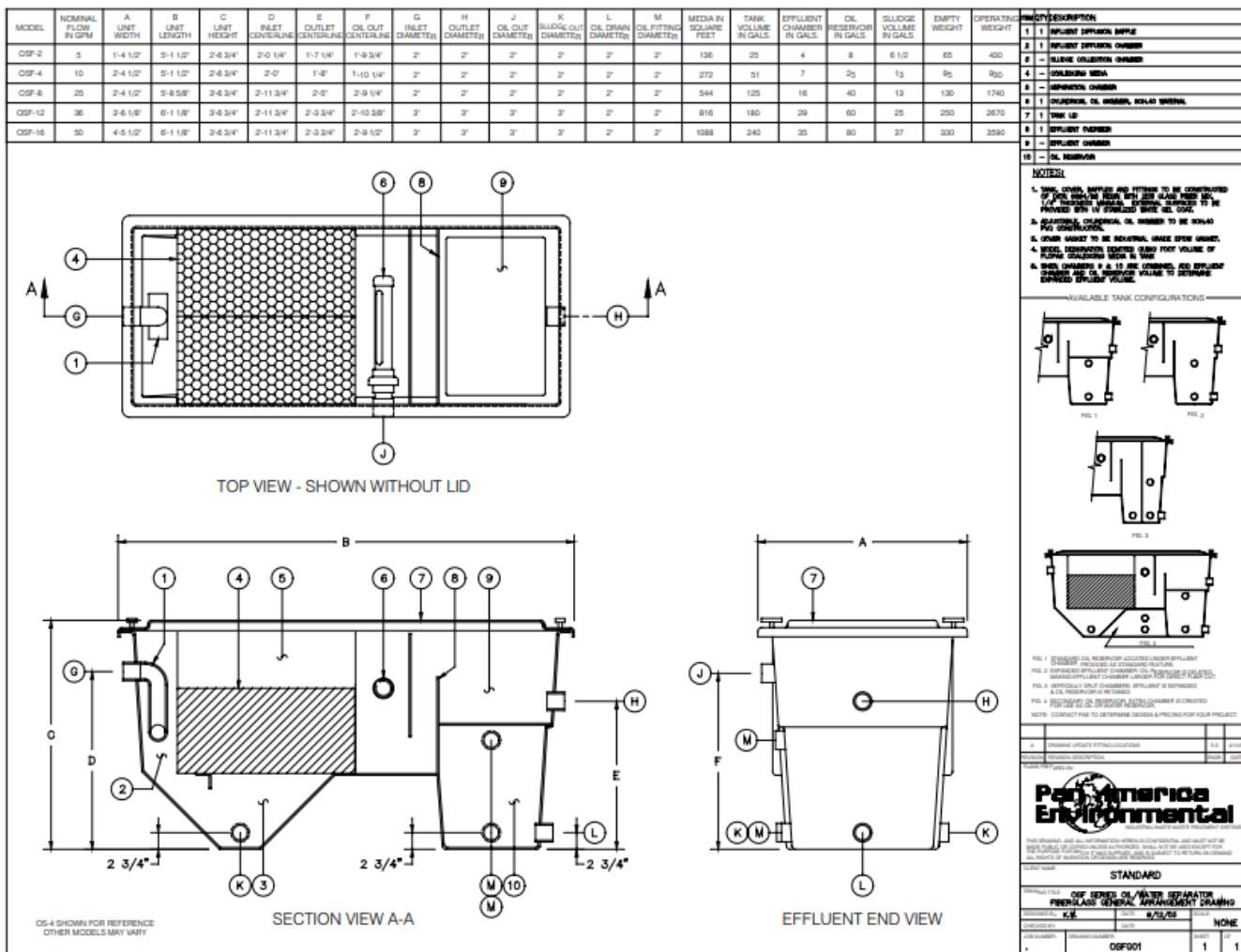

This equipment is in excellent shape and has been thoroughly cleaned.