



CEL-63x Environmental Noise Meter

HB3356-02

User Manual

Contents

Contents	2
1 Introduction	4
1.1 Structure of this User Manual	4
1.2 Safety	6
2 Features	8
3 Quick reference	9
3.1 Powering the instrument	9
3.2 Using the controls	11
3.3 Set the time and date	12
3.4 Calibrating the instrument.....	12
3.5 Making a measurement run.....	15
4 Detailed description.....	23
4.1 Microphone and pre-amplifier	23
4.2 User controls	23
4.3 Screen groups.....	24
4.4 Measurement views	45
4.5 Connections.....	52
5 Specifications	54
5.1 General.....	54
5.2 Standards.....	54
5.3 Measurement range.....	55
5.4 RMS frequency weightings.....	55
5.5 Octave and 1/3-Octave measurement	55
5.6 Peak measurement	55
5.7 RMS detector	55
5.8 Noise floor	55
5.9 Frequency response.....	55
5.10 Time weightings.....	55
5.11 Correction filters	56
5.12 Reference direction	56
5.13 Reference conditions.....	56
5.14 Operating environmental conditions.....	56

5.15	Effects of temperature.....	56
5.16	Effects of humidity	56
5.17	Storage environmental conditions.....	56
5.18	Microphones	57
5.19	Calibration.....	57
5.20	Power supply.....	57
5.21	Internal clock	57
5.22	Languages	57
5.23	Electromagnetic compatibility	58
5.24	Effects of AC power frequency fields.....	58
5.25	Tripod mounting	58
5.26	Display	58
5.27	Memory.....	58
5.28	Connectivity.....	58
5.29	Available data sets	59
5.30	Physical.....	62
6	Care and maintenance.....	63
7	Servicing and Warranty arrangements	64
7.1	Inspection and test.....	64
7.2	Lifetime Warranty Terms and Conditions	64
7.3	Repairs	65
7.4	User servicing	66
8	Glossary.....	67
9	Additional information	71
9.1	Sound calibrators – Level corrections.....	74
9.2	Response characteristics	75

1 Introduction

The CEL-63x series is a family of noise meters (where ‘x’ is a digit that indicates the model variant – see Figure 14 on page 54). These are powerful measurement tools to support a wide range of industrial, health and safety, and environmental noise measurement requirements.

For a breakdown of the different models and their functionality, refer to section 5 “[Specifications](#)” beginning on page 54.

The CEL-63x instrument uses the latest digital signal processing technology to provide a full range of functions, including integrating and real-time octave and 1/3-octave band analysis.

The CEL-63x instrument uses a colour TFT screen to show a range of information, including operating menus and messages, warnings, and the results of measurements. The screen is clear and easy to read under all ambient lighting conditions, including total darkness.

Measurements captured by the CEL-63x instrument conform to international standards for acoustic measurement. The measurements are saved automatically in high-capacity internal Flash memory. You can transfer the measurement results to a PC where you can manage the results and create reports by using the Casella Insight data management software.

1.1 Structure of this User Manual







The structure of this User Manual is designed to help you find the information and instructions you need to complete a task easily. Refer to section 3 “[Quick reference](#)” on page 9 for instructions to use the CEL-63x instrument.

If you need more information about any of the CEL-63x instrument’s controls, screens and features, then you should read the chapter called “[Detailed description](#)”, which begins on page 23.

To help you find the information you need quickly in the electronic version of this User Manual, it includes ‘clickable’ links. The links appear as blue underlined text. You can also click the names of chapters and sections in the bookmark panel, and in the [table of contents](#), to jump to that part of the manual.

Colour coding

The CEL-63x instrument’s screens use a colour code to help you identify their purpose quickly. This manual uses the same colour codes. Refer to section 4.3 “[Screen groups](#)” beginning on page 24 for more information.

<i>This colour...</i>		<i>indicates...</i>
Cyan		Memory results screens
Green		Measurement run screens
Red		Measurement stop screens
Yellow		Calibration mode
Blue		Menu screens
Grey		USB connection mode

1.2 Safety

The CEL-63x instrument does not present a safety risk when you use it as instructed in this User Manual. However, it is possible that the environment where you use the instrument may present a safety risk, and you must **ALWAYS follow correct, safe working practices.**



WARNING

Always be aware of the risks in the environment where you are working.

- The CEL-63x instrument is **NOT** intrinsically safe. **DO NOT** use it in an atmosphere where explosive vapours or dusts might exist.
 - Wear approved ear defenders when making measurements in noisy environments.
 - Wear approved protective clothing and footwear suitable for the environment where you are making measurements.
 - Always follow local safety regulations, and be aware of risks in the area where you are working.
-



CAUTION

Use the CEL-63x instrument only as instructed in this User Manual. Do not use the instrument for any purposes for which it has not been designed.



CAUTION

The CEL-63x is a precision instrument. Always handle it with care.

Do not use the CEL-63x instrument if it has been damaged. Refer to section 7 “[Servicing and Warranty arrangements](#)” on page 64 for instructions to follow if the instrument has been damaged or has developed a fault.



CAUTION

The CEL-63x instrument can operate from a battery power supply.

- Use only batteries of the correct type, and do not mix battery types in the instrument. Refer to "[Battery supply](#)" on page 9 for advice about battery types.
 - Do not try to charge non-rechargeable batteries.
 - Do not leave discharged batteries in the CEL-63x instrument.
 - Install new batteries as a complete set. Do not fit batteries that have a mixed state of charge. Refer to "[How to fit new batteries](#)" on page 9 for instructions to install batteries.
 - Remove all batteries from the CEL-63x instrument if you will not use the instrument for a long time.
 - Always follow local regulations to dispose of used batteries.
-



CAUTION

The CEL-63x instrument is not waterproof. Do not immerse the instrument in water or use it in the rain.

2 Features

Figure 1 shows the main features of the CEL-63x instrument. Refer to Figure 1 when you perform the tasks and instructions in this User Manual.

Figure 1. Main features of the CEL-63x sound level meter



1. Windshield (to cover the removable microphone)
2. Pre-amplifier (removable – pull the knurled body of the pre-amplifier connector away from the instrument body)



When you attach the pre-amplifier to the instrument, make certain the red dot faces towards the front of the instrument.

3. ON/OFF key
4. Display screen
5. Soft keys
6. Navigation keys
7. Run/Stop key

Refer to section 4.2 “[User controls](#)” on page 23 for a description of the Soft keys, of the Navigation keys, and of the Run/Stop key.

3 Quick reference

3.1 Powering the instrument

The options for powering the instrument are as follows:

- Batteries
- 12 V DC adaptor (part number -PC18)
- USB connection (part number -CMC51)

Battery supply

You can use alkaline or rechargeable AA batteries to operate the instrument. Do not use a mixture of alkaline and rechargeable batteries at the same time.

The operating time that you can expect from a fully charged or new set of batteries depends on the battery capacity and whether you use the instrument's backlight. Environmental conditions such as the ambient temperature also affect battery life. See section 5 "[Specifications](#)" beginning on page 54 for some typical battery life examples.

You should also carry a spare set of batteries.



IMPORTANT

To save power when operating on batteries, the CEL-63x instrument switches OFF automatically if no measurement run is in progress and there is no key-press activity for five minutes.

You should operate the instrument on a mains DC power supply if you must leave it unattended while making an extended measurement run. The instrument does NOT switch off automatically when it operates from a mains DC supply.

How to fit new batteries

Before you begin:

Read the caution notice about [Batteries](#) on page 7.

You should check that the batteries have adequate battery life before you begin a measurement. Replacement batteries should be new or fully charged.

Fitting the batteries

You do not need any special tools to fit new batteries to the instrument.

1. If necessary, press and hold the ON/OFF key to switch the instrument OFF.
2. Remove the three exhausted batteries from the battery compartment.
3. Fit fully-charged batteries into the battery compartment, observing the polarity markings.
4. Press and release the ON/OFF key, and check the battery symbol shows the batteries have a good charge.

Mains DC supply

If you need to operate the instrument for a long period, you should operate the instrument from a mains DC power supply if possible. The use of AA batteries is also recommended in case of power interruption.

The instrument DOES NOT include a mains DC supply as standard. Please obtain and use an optional Casella power supply (part number -PC18).



NOTE

The CEL-63x instrument disconnects the internal batteries when you connect a mains DC supply to it. The batteries do not recharge when you operate the instrument from a DC supply.

If you use rechargeable batteries with the CEL-63x instrument, you must use an external battery charger of the correct type to charge the batteries. Follow the charging instructions supplied by the battery manufacturer to charge the batteries.

USB supply

When you connect the instrument to a PC through a USB cable, the instrument receives power to operate at 5 V DC from the PC. There is no need to use a mains DC power supply to operate the CEL-63x instrument when you connect it to a PC.

Battery condition indicator

When the CEL-63x instrument receives power from a mains DC power supply or from a USB port on a PC, the battery condition symbol on the instrument's screen always shows a fully charged battery condition, even if the batteries are not fully charged.

3.2 Using the controls

The CEL-63x instrument is designed to allow easy operation. The instrument has only seven (7) control keys, shown on the right. These are as follows:

- The Soft keys (A and B).
- The Navigation keys (C) ▶ ◀ ▼ ▲.
- The Run/Stop key (D) ▶ ■.

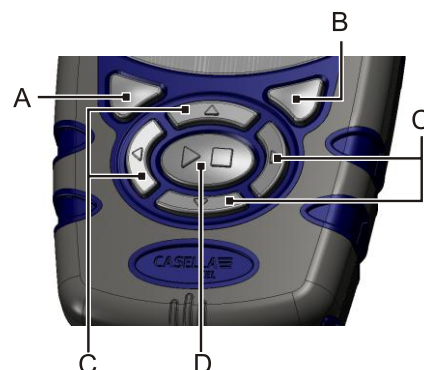

The instrument is small in size, and it is usually possible to hold and operate it using only one hand. For safety, you can attach a wrist strap near the bottom of the instrument.

The simple descriptions below show the purpose of the user control keys. Refer to Section 4.2 “[User controls](#)” on page 23 for a full description of the user controls.

Soft keys

The Soft keys A and B allow you to select between the two options showing at the bottom of the screen. These two options change, depending on which screen is showing on the instrument’s display.

Navigation keys

The four Navigation keys allow you to select items on the main part of the screen. Press the ▶, ◀, ▲ or ▼ Navigation key to change to the next selection in the direction of the arrow.

Run/Stop key

The Run/Stop key ▶ ■ allows you to start and to stop a Run.

Press the ▶ ■ key when the instrument is in the Stop mode to start the Run. Refer to [Measurement stop](#) on page 26 for information about the Stop mode.

Press the ▶ ■ key during a Run to stop the Run.

3.3 Set the time and date

Follow the steps below to set the clock.

1. Press and release the ON/OFF key to switch the instrument ON.
2. Wait approximately 10 seconds until the instrument's initialization screen changes to the Status screen.
3. Press the Menu Soft key to see the instrument's Settings menu.
4. Follow the instruction steps shown in Figure 2 to set the time and the date.



NOTE

You can set the instrument's clock to the exact time by setting the hour and the minute, and then pressing the **Save** Soft key when the second hand of a reference clock reaches the start of the minute.

Figure 2. Setting the time and date

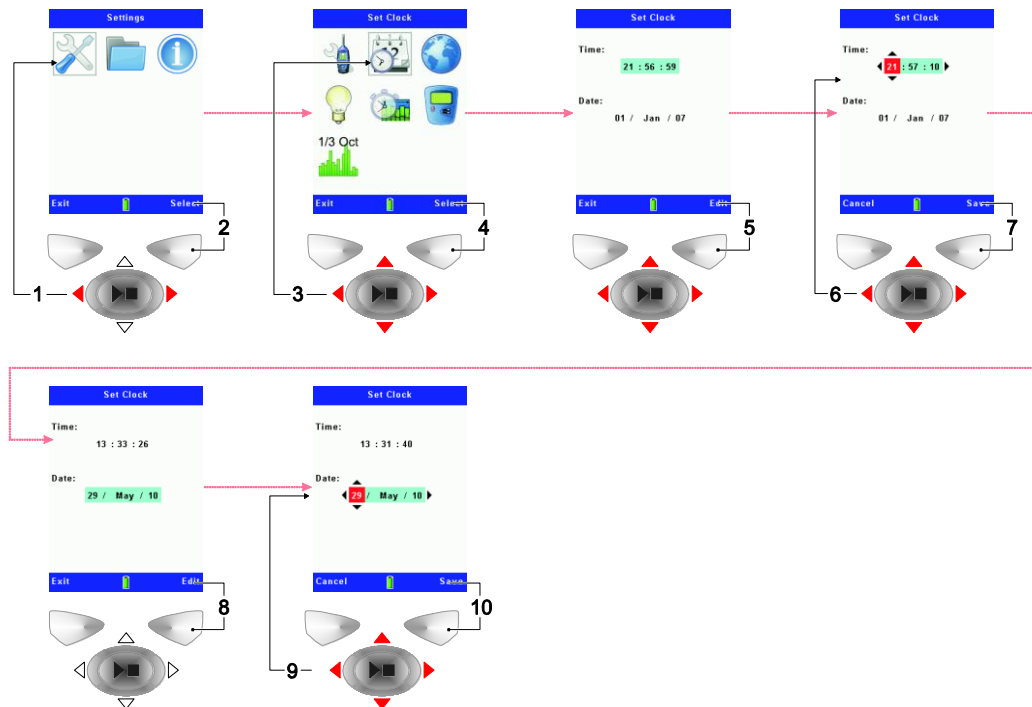

3.4 Calibrating the instrument

The CEL-63x is a precision measuring instrument. You should calibrate it before each measurement run and again after each measurement run so that you can be certain its measurements are accurate.

To calibrate the instrument you will need a suitable calibrator that generates a 1 kHz reference tone. Depending on the type of calibrator, the reference tone can have a nominal sound pressure level of either 94 dB or 114 dB. Check the information supplied by the calibrator manufacturer to find the exact sound pressure level that the calibrator generates.

Each measurement run stores both the before-run and the after-run calibration results, including any changes in the calibration. This confirms the absolute accuracy of the measurement.



NOTE

It might be necessary to change the calibration reference level so that it includes the pressure-to-free field correction applicable to the fitted microphone. For Casella microphones, and assuming a 114.0 dB nominal calibrator pressure, the reference level should be as follows:

- CEL-251 or CEL-252 = 114.0 dB (if using windshield)
- CEL-251 or CEL-252 = 113.9 dB (without windshield)

1. Remove the windshield from the CEL-63x instrument's microphone.
2. Press and release the ON/OFF key to switch the instrument ON.
3. Wait approximately 10 seconds until the instrument's initialization screen changes to the Status screen.
4. Press the **Menu** Soft key to see the instrument's **Settings** menu.
5. Follow the instruction steps shown in Figure 3 to set the instrument's calibration reference level so that it is the same as the sound pressure level that the calibrator generates.

Figure 3. Setting the instruments calibration reference level

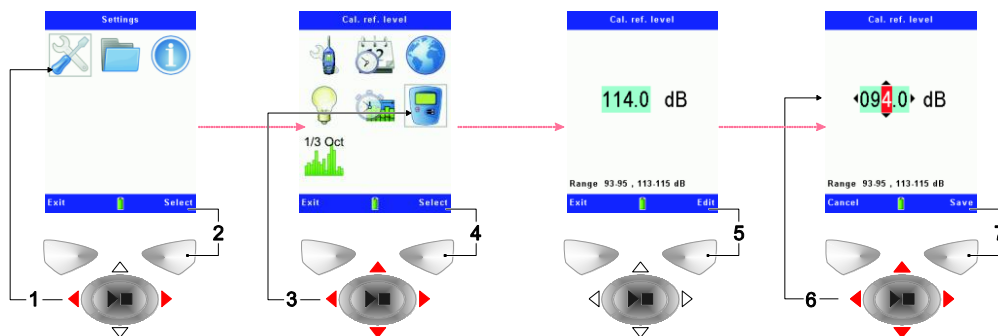

6. Save and exit to the Measurement screen.
7. Gently fit the calibrator to the instrument's microphone and press it into position as shown in Figure 4.

Figure 4. Instrument calibration

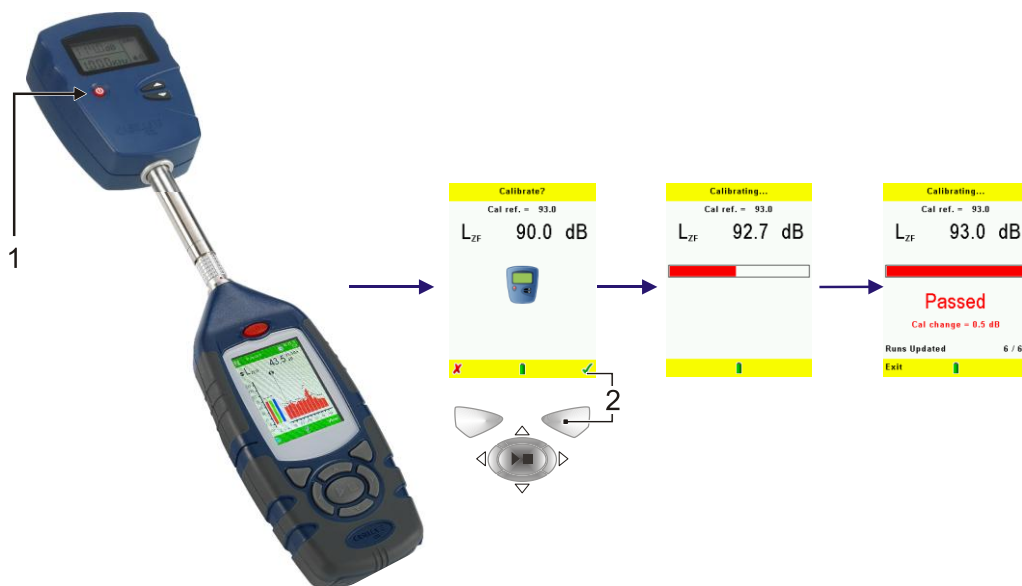

8. Press the ON/OFF key on the calibrator (item 1 in Figure 4) to switch the calibrator ON.

The CEL-63x instrument selects the calibration screen automatically when it detects a stable 1 kHz calibration tone.



NOTE

Calibration mode operates only in Stop mode (when the instrument shows red screen bars). It does not operate while a run is active.

9. Follow the instruction steps in Figure 4 to complete the calibration and save the results.

Note that the calibration takes typically less than 10 seconds to complete and for the screen to display the word “PASSED”.

10. Press the Exit soft key on the instrument.
11. Press and hold the ON/OFF key on the calibrator to switch the calibrator OFF.
12. Remove the calibrator from the instrument’s microphone, and re-fit the microphone’s windshield.

You have now calibrated the CEL-63x instrument and made it ready for a measurement run.

3.5 Making a measurement run

The CEL-63x instrument measures, calculates and records all noise functions simultaneously during a measurement. In this manner it removes the need for critical set up of the instrument before any measurement.

Measurement runs can be recorded as cumulative or periodic data sets, as well as a fast profile time history. For an explanation of these modes, refer to [“Measurement data sets”](#) beginning on page 20.

Measurement view

The measurement view simply defines which functions you view on the instrument’s screen, either while making a measurement or while reviewing measurements recorded previously.

The instrument has a wide range of measurement view options that you can choose. The individual types of instrument in the CEL-63x range offer different views. Refer to section 5 [“Specifications”](#) beginning on page 54 for more information.

- There are four fixed views that meet international requirements for workplace noise measurements. You can review the functions displayed for each of these fixed views, but you cannot change them.
- There are two fixed views for environmental noise measurements. These views display the functions that are commonly reported for environmental measurements. You can review the functions for each of these fixed views, but you cannot change them.
- There are two user-defined views that allow you to review and change the measurement functions.

Use the Navigation keys to select one of the measurement view options, and press the right-hand Soft key to set the measurement view. The screen shows the word “Active” next to the measurement view you have set.

[Figure 5](#) on page 16 explains how to select a fixed measurement view and how to review the functions for the selected measurement view.

[Figure 6](#) on page 17 explains how to select a user-defined measurement view and how to review and change the functions that it uses.

Fixed measurement view

Figure 5. Set a fixed measurement view

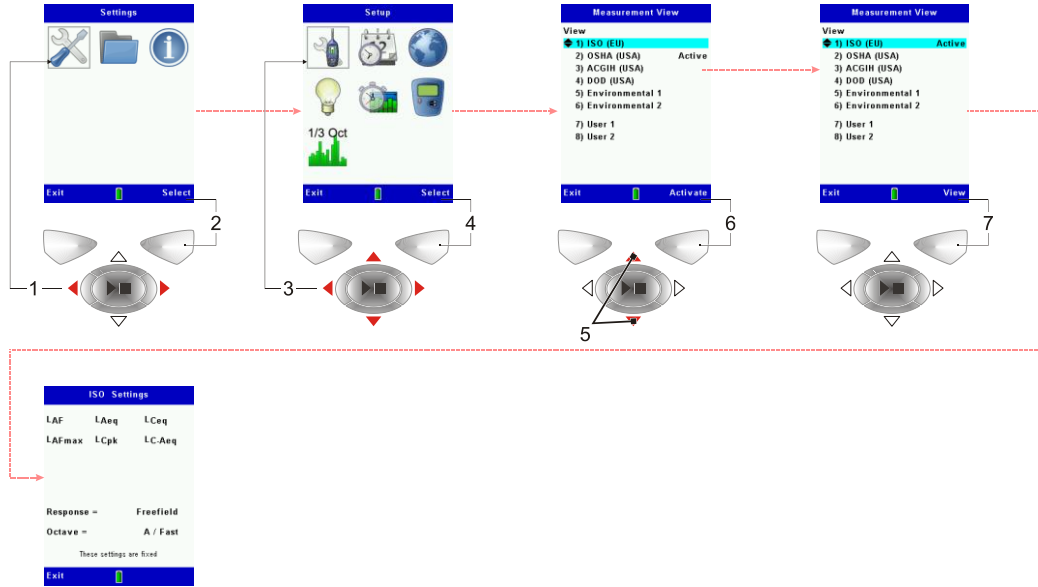

User-defined measurement view

Figure 6. Set a user-defined measurement view

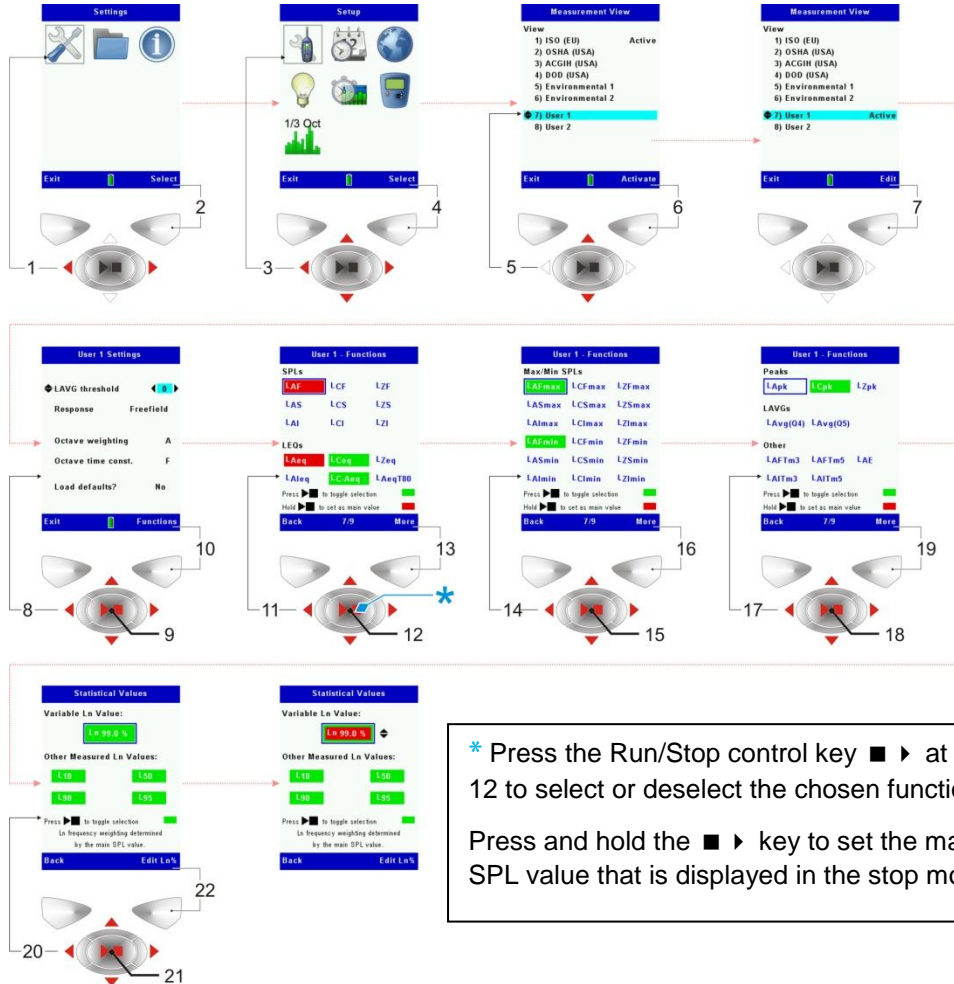

* Press the Run/Stop control key at step 12 to select or deselect the chosen function. Press and hold the key to set the main SPL value that is displayed in the stop mode.

Refer to Section 4.4 “[Measurement views](#)” on page 45 for a description of the User 1 and User 2 settings that you can use.

Measurement controls

These settings control how the instrument starts and stops each measurement run. You can choose among three options.

Figure 7 explains how to select each of the timed operation modes.



NOTE

For measurement runs that have a long duration, you should use a mains DC power supply to operate the instrument.

Key press

The key press mode allows you to start and stop each measurement run by pressing the Run/Stop key.



This 'manual control' of the instrument is useful when you do not know the duration of a measurement run.



Fixed duration

The fixed duration mode allows you to set the duration of a run. You can set the duration in steps of one second, in the range 00:00:00 to 24:00:00 (HH:MM:SS).



You must press the Run/Stop key to start the run manually, but the instrument will stop the run automatically after the duration you have set. If necessary, press the Run/Stop key to stop the run early.



The fixed duration mode is useful if you need to make a single measurement run where you know the duration but you do not know the exact time when the measurement run must start.

Timers

The timers mode allows you to set the day of the week and the time when a run starts and stops. You can set the instrument to start and stop one or more runs on different days and at different times.

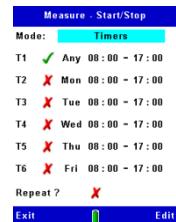

You can set the pattern of runs to occur only once, or you can set the pattern of runs to repeat on the same days and at the same times each week.

When you use the timers mode you must leave the instrument switched ON from the start of the first run until after the end of the last run. You must therefore operate the instrument from a mains DC power supply so that the measurement runs occur without interruption.

This timer mode is especially useful when the instrument is used together with the environmental kit case. This enclosure supports a higher capacity battery for short- to medium-term environmental measurements.

Figure 7. Measurement controls

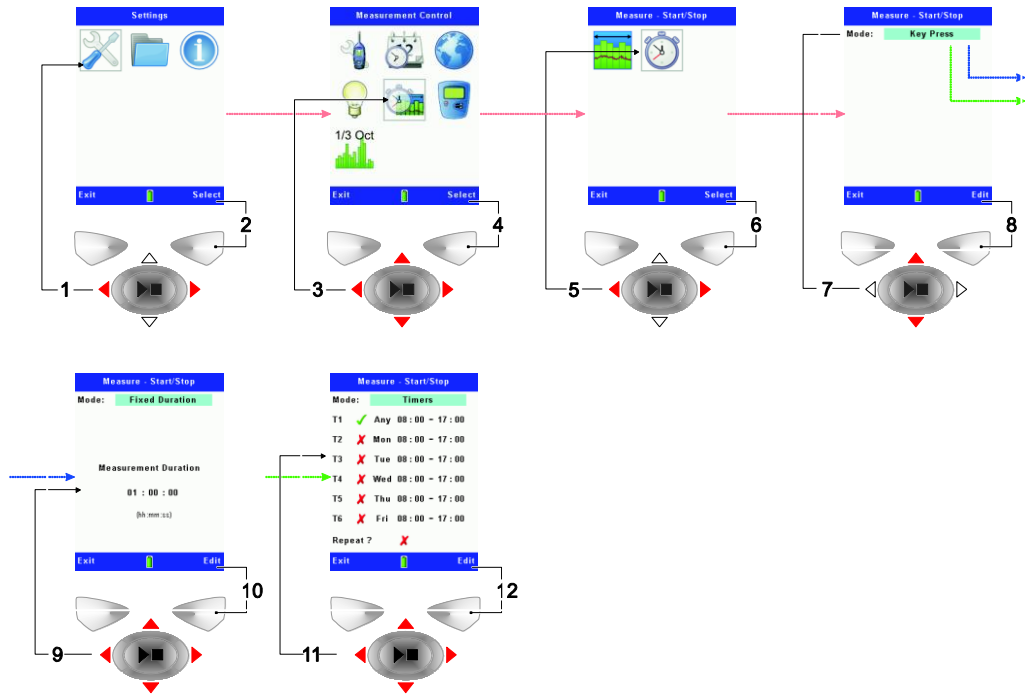

Measurement data sets

The data sets option controls how the CEL-63x instrument records measurements during a run. There are two options that you can choose.

- [Cumulative measurements.](#)
- [Periodic measurements.](#)

Both options can be used with [Profile recording.](#)

Figure 8. Measurement data sets

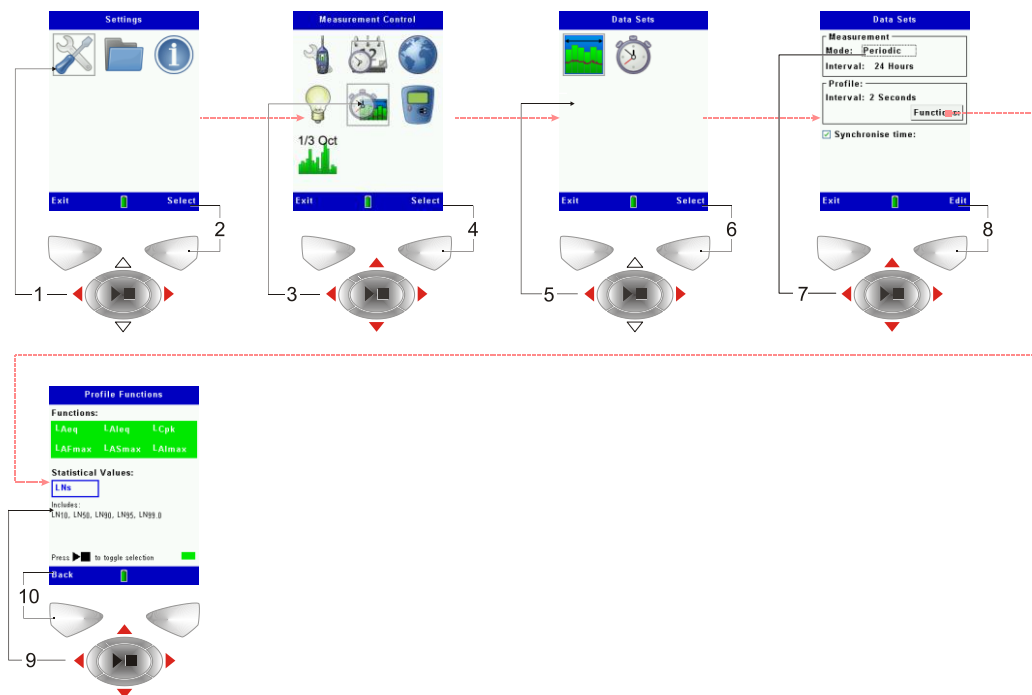

Cumulative measurements

A cumulative measurement produces a single set of results for the entire measurement duration.



When you use the CEL-63x instrument in cumulative measurement mode, the start and stop times depend on whether you have selected [Key press](#), [Fixed duration](#) or [Timers](#) for the instrument.

The cumulative data set alone does not provide time history information. To include time history information for the measurement, you can enable Profile recording.

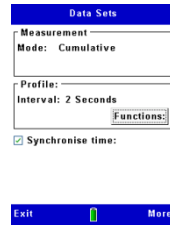

Profile recording

A profile recording consists of a series of fast measurements made at the same time as a cumulative measurement.

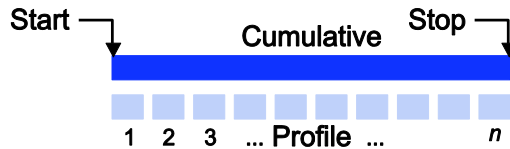

The profile recording supports a more limited set of functions, including L_{Aeq} , L_{Aeq} , L_{Cpk} , L_{AFmax} , L_{ASmax} , L_{AImax} , and optional $L_n\%$ statistics (*Broadband Fast A-weighted Lns only*).

When you use profile recording, you can set the interval of each of the profile measurements to one of the following:

- OFF
- 1, 2, 5, 10, 15, 20, 30, 60 seconds
- 2, 5, 10, 15, 20, 30, 60 minutes



NOTE

When used with periodic recording, the profile interval can only be set to a sub-interval of the cumulative measurement duration to produce an exact number of profile samples per period.

Periodic measurements

Periodic measurements allow the total measurement duration to be divided into separate fixed time intervals. In Periodic mode, a full set of results is stored at the end of each time interval, whereas in Cumulative mode a single full set of results is stored at the end of the measurement run.

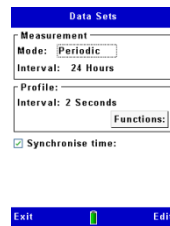

In effect, the original full set of cumulative results is captured at periodic measurement intervals.

Figure 9. Repeating cumulative and profile data sets

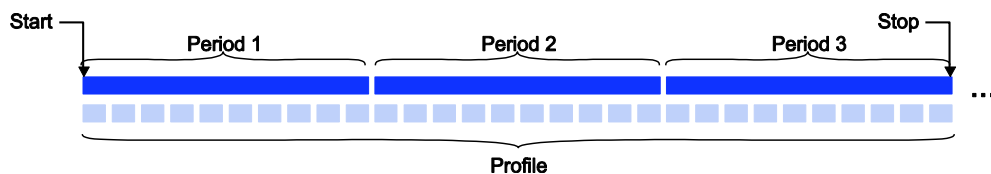

To select the Periodic data capture mode, set the Data Sets **Mode** control to **Periodic**, and then select the Periodic Interval. The Periodic Interval is the time from the start of one period to the start of the next period. You can set the Periodic Interval to one of the following:

- 1, 2, 5, 10, 15, 20, 30 or 60 minutes
- 2, 4, 6, 8, 12 or 24 hours

Synchronise time

The **Synchronise Time** option synchronises both the periodic and the profile times to the actual time. For example, if a periodic time is 1 hour and a run starts at 09:18 with this option enabled, then the first period finishes at 10:00. The second and all subsequent periods start on the whole hour.

The profile measurements are similarly synchronised to the period interval.

If the **Synchronise Time** option is disabled, then in this example the first period continues to 10:18; the second period continues to 11:18, and so on.

You can also synchronise runs by using the timers, by starting and ending runs on whole time period intervals. This synchronises both the periodic and the profile measurements.

4 Detailed description

4.1 Microphone and pre-amplifier

The CEL-63x instrument has a removable 1/2-inch (12.7 mm) microphone. This is a pre-polarised microphone that uses a permanently charged material in its construction.

The instrument is supplied with a windshield. The windshield provides protection from wind and from minor mechanical damage. The windshield should always be fitted to the microphone.

There are two classes of microphone available, which have different sensitivities.

- The Class 1 microphone (CEL-251) has 50 mV/Pa sensitivity
- The Class 2 microphone (CEL-252) has 30 mV/Pa sensitivity

4.2 User controls

Soft keys

The Soft keys select between the two options showing at the bottom of the screen. These two options change, depending on which screen is showing on the instrument's display. Therefore, the Soft keys can have different functions, depending on which screen the instrument is showing.

Usually, you must press the Soft key on the right to select a function, and you must press the Soft key on the left to exit a screen or cancel a function.

Press the Soft key for the option that you need to select that option.

Navigation keys

The four Navigation keys allow you to select items on the main part of the screen. Press the ▶, ◀, ▲ or ▼ Navigation key to change to the next selection in the direction of the cursor arrow.

Run/Stop key

The Run/Stop key ▶ ■ allows you to start and to stop a run.

Press the ▶ ■ key when the instrument is in the Stop mode to start the run. Refer to [Measurement stop](#) on page 26 for information about the Stop mode.

Press the ▶ ■ key during a run to stop the run.

4.3 Screen groups

The CEL-63x instrument has groups of screens that allow you to set up and operate the instrument, and to see the results of the instrument's measurements. The screens have colour-coded bars at their top and bottom edges, to help you identify which screen group they belong to. Refer to [Colour coding](#) on page 4 and Figure 10 below for the colour codes.

Note that the contents of some screens may vary, depending on the model of instrument you are using.

Figure 10. Screen groups

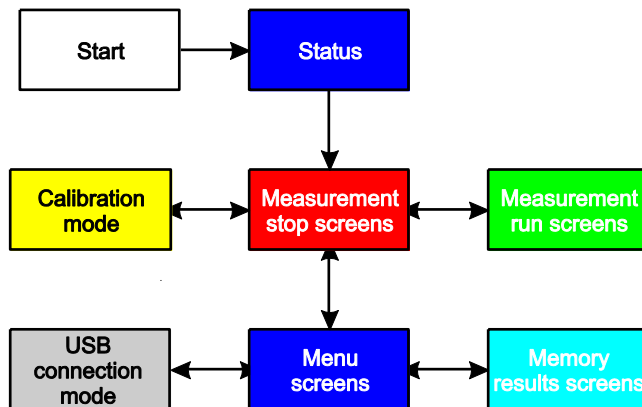

Each screen group includes one or more separate screens.

Figure 10 shows how the screen groups relate to each other. Click any of the groups shown in Figure 10 to read a description of that group.

Switch-on

The CEL-63x instrument shows an introduction screen after you switch the instrument ON. The introduction screen shows the following information about the instrument:

- The model number of the instrument (for example, CEL-63x).
- The instrument's serial number.
- The firmware version that is operating inside the instrument.
- User-defined details, for example the user's name. These details must be set up by using the Casella Insight data management software PC software, and then transferring them to the instrument.

Write the serial number and the firmware version number in a safe location. You should give this information to the service agent if the instrument develops a fault.



NOTE

This screen also provides access to system tools. These tools enable the internal memory to be reformatted, allow setting the memory to be read/write from the connected PC, and allow setting the AC output on the bottom socket to output the low or high part of the dynamic range. They also allow selection of either 140 dB or 165 dB full-scale modes.

Status

The Status screen shows the following information about the instrument's current operating condition:

- The current date and time.
- Runs free
- The battery voltage. Refer to [Battery supply](#) on page 9 for more information about battery types.
- The type of response field the instrument is using.
- The pre-defined setup used by the instrument.

You cannot make changes to the displayed setting.

Measurement stop screen

The measurement stop screens show the current instantaneous sound pressure level. Different screen views include the following:

- The [Octave screen](#).
- The [Graph screen](#).

Select the **View** option to toggle between the two screens.

Select the **Menu** option to use the setup screens. Refer to [Menu screens](#) on page 32 for instructions to use the setup screens.

Octave and 1/3-Octaves

The Octave and 1/3 -Octave screen includes an octave spectrum graph showing instantaneous and maximum noise levels for each filter band, plus A, C and Z broadband measurements.

Short lines above the individual bars show the maximum measurements for each filter band.

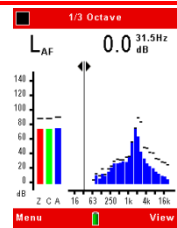

You can use the navigation cursor keys to select individual bars on the screen. The screen shows the following measurements digitally:

- The centre frequency of the selected octave, for example 2 kHz.
- The sound pressure level (dB) of the measurement in the selected octave.
- The functions used for the measurement, for example L_{AF}.

Graph

The Graph screen shows a single line graph using a vertical scale of noise level and a horizontal scale of time.

The bar moves up and down to show the noise level, and the graph scrolls to the left to show noise level over time.

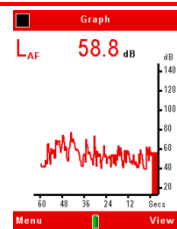

Overload

An arrow pointing upwards  near the top right-hand corner of the screen shows that an overload noise level that exceeds the instrument's measurement range has occurred.

If this occurs, the measurement values shown will be incorrect, and you may need to consider the validity of any measurements made.

Calibration mode

The CEL-63x instrument changes automatically from Stop mode to Calibration mode when it detects a stable 1 kHz calibration tone.

The Calibrate mode has two separate screens.

- The [Start calibration](#) screen.
- The [Calibration progress](#) screen.

Start calibration

The Start calibration screen shows the setting for calibration reference level, and the level of calibration tone that the instrument is measuring.

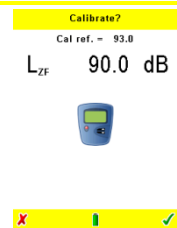

IMPORTANT

You must make sure the instrument is set to use the same calibration reference level as the calibrator. Refer to the calibrator's manual for this information, and refer to [Calibration reference level](#) on page 38 for instructions to change the instrument's setup.

The Start calibration screen has two options:

- ✓ - The green tick symbol allows you to start the calibration process.
- ✗ - The red cross symbol allows you to exit the Calibration mode.

Calibration progress

After you start the calibration process, the Calibration progress screen shows a horizontal progress bar and the level of calibration tone that the instrument is measuring.

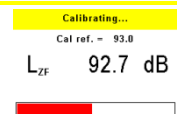

After the calibration process finishes, this screen shows whether the calibration has passed or failed.

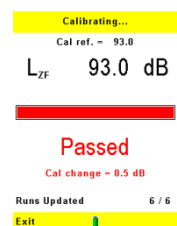

When the calibration passes, it is saved automatically.

If the calibration fails, this indicates a technical problem with either the instrument or the calibrator. The basic checks to try if the calibration fails are as follows:

- Check that the microphone and calibrator are fitted correctly.
- Inspect the microphone and the calibrator's cavity for signs of damage.
- Check that the calibration level is set correctly.

If the instrument persists in failing calibration, contact Casella CEL for advice.

Press **Exit** to exit the Calibration mode without saving the new calibration.

Measurement run screens

The CEL-63x instrument captures measurements when it operates in the Run mode. The functions displayed depend on settings defined by the Measurement View in the instrument's setup. Refer to [Measurement View](#) on page 32 for instructions to change the instrument's setup.

The Run mode has five types of screen.

- The [Main screen](#).
- The [Graph screen](#).
- The [Octave and 1/3-Octave](#) screen.
- The [Values screen](#).
- The [Marker screen](#).

All the measurement run screens show the Run number, and the Run duration. Each screen also has a pause control  and a View option.

Select the **View** option on each screen to change from one screen to the next.

Main screen

The Main screen shows measured function values numerically and as a series of bars against a vertical scale.

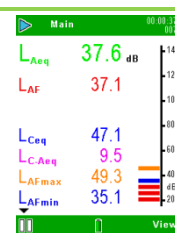

Ln's screen

The Ln's screen shows statistical Ln measurements for the run. Depending on model refer to [page 54](#)

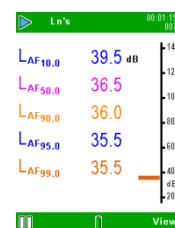

Octave and 1/3-Octave screens

The Octave and 1/3-Octave screens show measurements for the octave or 1/3-octave spectrum bands and A, C, Z values.

You can use the navigation keys to select individual bars on the screen. The screen shows the following measurements digitally:

- The centre frequency of the selected octave, for example 2 kHz.
- The sound pressure level (dB) of the measurement in the selected octave.
- The name of the measurement function, for example L_{Aeq}.

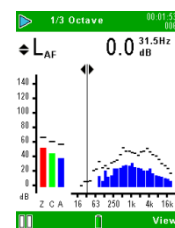

Values screen

The Values screen shows a list of the centre frequencies for each octave or 1/3-octave, and columns of measurements (for example to show L_{Aeq} , L_{AFmax}) for each of the centre frequencies.

Depending on instrument model additional frequency bands and statistical values may be viewed by using the navigation keys to scroll the display.

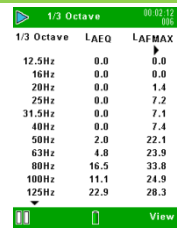

Graph screen

The Graph screen shows a graph of the CEL-63x instrument's measurements taken over a period of time. The graph has a horizontal scale of time, and a vertical scale of sound pressure level (dB).

The more recent measurements are to the right of the graph.

The graph scrolls slowly to the left during the Run. Measurements that are older than the displayed time span disappear at the left end of the graph.

The Graph screen also shows measurements digitally using different functions.

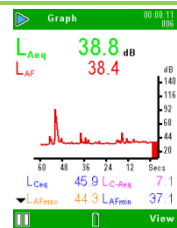

Marker screen

The Marker screen allows you to tag noise data with a specific identity using one of four markers. For example, you can tag the data to identify it as noise from an aircraft or from a road vehicle.

Back erase

By pressing Pause when cumulative measurements are being made, 'back erase' becomes available. The back erase option allows you to remove up to the last 10 seconds of noise data from the cumulative result. Note that if the measurement has not been running for 10 seconds, back erase will erase up to the start of the measurement.

The functions viewed on this screen can be changed.

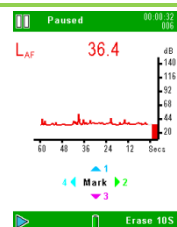

Menu screens

The CEL-63x instrument's Menu mode has three options:

- The [Settings](#) option allows you to change the instrument's setup.
- The [Memory results](#) option allows you to view information stored in the instrument's internal memory.
- The [Instrument status](#) option displays the instrument's current operating status.



Settings

There are seven main options in the Settings screen:

- [Measurement View](#) allows you to set the measurement view or to create user-defined measurement views.
- [Set Clock](#) allows you to set the date and time, or to change the date and time settings.
- [Language](#) allows you to set the language used for the instrument's screens.
- [Backlight](#) allows you to set the duration and level of backlight illumination.
- [Measurement Control](#) allows you to set the method used to start and stop measurements, and allows you to set whether you are measuring Cumulative or Periodic data sets.
- [Calibration reference level setup](#) allows you to set the instrument to use the correct sound pressure level for the calibrator.
- [Meter Mode](#) allows you to select either octave or 1/3-octave measurements on B & C models.



Measurement View

The CEL-63x instrument has up to six fixed measurement views, and two user-defined measurement views.

The fixed measurement views have functions that are defined to meet national regulations. You cannot change these functions.

This screen shows the measurement view that is active, and allows you to select a different measurement view.

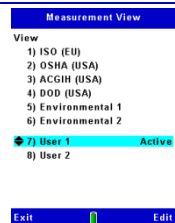

User settings

The table below lists the functions that you can change in a user-defined measurement view. This table also shows the range of each setting. Refer to section 4.4 “[Measurement views](#)” on page 45 for an explanation of the User 1 and User 2 settings.

Table 1. User settings

User function	Range		
Average sound pressure level (L_{Avg}) threshold	0 dB or 70 dB to 90 dB		
Sound field response	Freefield	Random	
Octave weighting	A, C or Z.		
Octave time constant	F (fast), S (slow)		
Sound pressure level (SPL)	L_{AF} L_{AS} L_{AI}	L_{CF} L_{CS} L_{CI}	L_{ZF} L_{ZS} L_{ZI}
Equivalent continuous sound pressure level L_{eq}	L_{Aeq} L_{Aeq}	L_{Ceq} $L_C - L_A$	L_{Zeq} L_{AeqT80}
Maximum and minimum sound pressure level	L_{AFmax} L_{ASmax} L_{AImax} L_{AFmin} L_{ASmin} L_{AImin}	L_{CFmax} L_{CSmax} L_{CImax} L_{CFmin} L_{CSmin} L_{CImin}	L_{ZFmax} L_{ZSmax} L_{ZImax} L_{ZFmin} L_{ZSmin} L_{ZImin}
Peak sound pressure level	L_{Apk}	L_{Cpk}	L_{Zpk}
Average sound pressure level with exchange rate Q	$L_{Avg(Q4)}$	$L_{Avg(Q5)}$	
Other measurements (refer to Measurement views on page 45)	$L_{AF(Tm3)}$ $L_{AI(Tm3)}$	$L_{AF(Tm5)}$ $L_{AI(Tm5)}$	L_{AE}
Statistical functions (L_n)	L_{10} L_{95}	L_{50} L_n variable	L_{90}
Environmental indices	LDN	LDEN	CNEL

Set Clock

The CEL-63x instrument has an internal clock, which allows the instrument to record the date and time of each measurement.

The Set Clock screen allows you to set the date and the time, and to change the settings when necessary.



Language

The CEL-63x instrument can display the screens using any of nine languages. When you change this setting, the instrument also changes the format used to display some information, for example the date.

The language options are as follows:

- UK English.
- US English (when using this, only the date format changes).
- Brazilian Portuguese.
- French.
- German.
- Italian.
- Portuguese.
- Spanish.
- Chinese.



Backlight

The CEL-63x instrument has a display backlight. The backlight allows you to use the instrument in poor ambient lighting conditions, or in darkness.

The Backlight screen allows you to change the following backlight's settings:

- Set the backlight permanently ON, or set the backlight to come on after a key press.
- Set how long the backlight remains ON after a key press.
- Set the brightness level of the backlight.



Measurement Control

The measurement setup allows you to set the measurement start and stop modes, and to set the measurement capture mode.

Measurement start and stop modes

There are three methods available to start and stop the CEL-63x instrument's measurements.



IMPORTANT

Note that the CEL-63x instrument stops capturing measurements, saves the current measurement results, and then shuts down if the battery charge fails during operation. Make sure the batteries have sufficient charge to allow continuous operation for the full measurement period.

For long measurement periods, consider operating the instrument using a mains power supply. Refer to section 3.1 "[Powering the instrument](#)" on page 9 for information about power supply options.

- Start and stop measurements by pressing a key.

The instrument starts to capture measurements when you press the Run/Stop key, and continues to capture measurements until you press the key again.

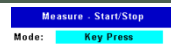

- Fixed duration measurements.

In the fixed duration measurement mode, the instrument starts to capture measurements when you press the Run / Stop control key  key. It continues to capture measurements for the period set by this screen.



- Timer measurements.

The CEL-63x instrument can start and stop measurements automatically on preset days and times.

You can set different start and end times for each day of the week, and you can set the instrument to capture measurements during more than one period on each day. You can also set the instrument to capture measurements for the same time period on every day. Press the Run/Stop key to set the standby mode until the start of the run.

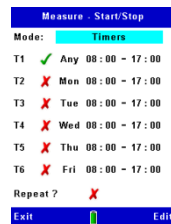

Timers

When the Run/Stop key is pressed to start a timed sequence of runs, the CEL-63x instrument finds the first enabled timer starting from T1 and waits until the start day and time defined by that timer. The instrument then performs the run.

On completion of the run, the instrument then finds the next enabled timer T2 to T6 and waits for the indicated start day and time.

When the instrument has cycled through all six timers, it either stops the run sequence or, if the **Repeat** option is enabled, it repeats the sequence continuously from the beginning.

The timers can be set to run on a specific day of the week at a specific time (7-day timer), or to start on any day of the week at a specific time (24-hour timer).

The start time for a timer can be the same as the end time for the previous timer so that, unlike some meters, the CEL-63x does NOT require a number of seconds when noise is not measured between runs to perform housekeeping operations.

Data sets

The measurement data sets option sets how the CEL-63x instrument captures measurements over a period of time.

You can set the instrument to capture measurements during a single run. These are called cumulative measurements.

You can set the instrument to capture repeated measurements to create a periodic time history.

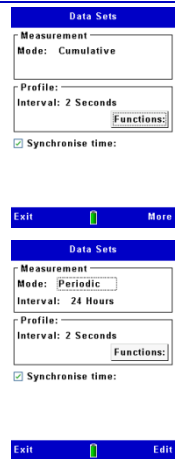

Figure 11. Cumulative measurements and Periodic Time History

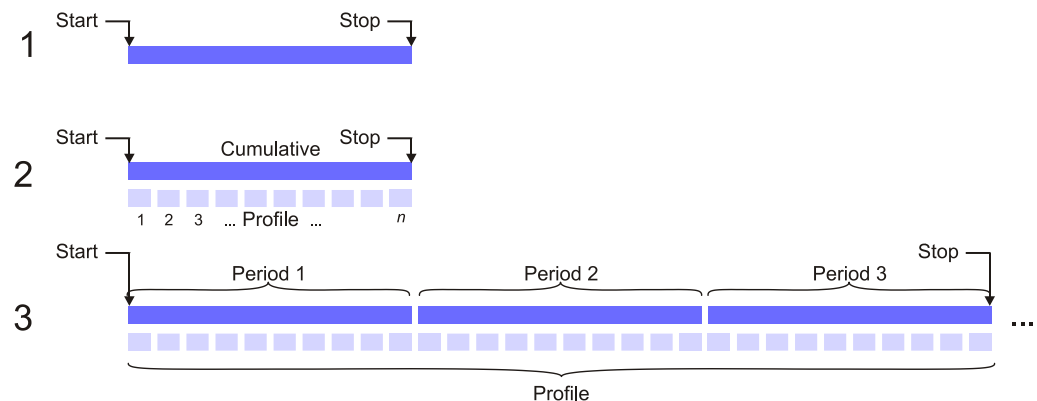

Figure 11 shows three examples of cumulative measurement runs and periodic time histories.

1. This example is a single cumulative measurement run as a dark blue line. The duration of the run is set by the [Measurement start and stop modes](#). You can use the screens in the [Memory results](#) to see the captured measurements as a graph or as values. The measurements are stored in memory and can be transferred to a computer by USB.

2. This example is a single cumulative measurement (shown as a dark blue line) together with a profile channel (shown as a light blue line).

The profile channel consists of a series of many measurements captured at the same time as the single cumulative measurement. You can set the profile interval from one second to 60 minutes.

3. This example shows periodic data sets as a series of dark blue lines, and the profile channels that go with the periodic data sets as light blue lines.

The Casella Insight data management software is used to combine and graph the periodic data.

Calibration reference level setup

The calibration reference level screen allows you to set the CEL-63x instrument to use the same sound pressure level as the calibrator.

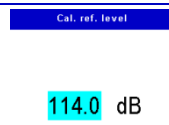

Documents supplied with the calibrator should tell you what sound pressure level it delivers at the 1 kHz reference tone. This will be in the range 93 dB to 95 dB, or in the range 113 dB to 115 dB.



This screen allows you to set the instrument to the same calibration level, to an accuracy ± 0.1 dB.

Meter Mode

The Meter Mode option allows you to set whether the CEL-63x instrument displays measurements octave or $\frac{1}{3}$ -octave frequency bands.

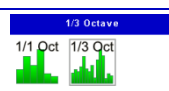

Table 2 below lists the octave and $\frac{1}{3}$ -octave centre frequencies, and the upper and lower frequencies of each band.



Table 2. Octave band frequencies

Octave			1/3-Octave		
Lower cutoff frequency (Hz)	Centre frequency (Hz)	Upper cutoff frequency (Hz)	Lower cutoff frequency (Hz)	Centre frequency (Hz)	Upper cutoff frequency (Hz)
22	31.5	44	22.4	25	28.2
			28.2	31.5	35.5
			35.5	40	44.7
44	63	88	44.7	50	56.2
			56.2	63	70.8
			70.8	80	89.1
88	125	177	89.1	100	112
			112	125	141
			141	160	178
177	250	355	178	200	224
			224	250	282
			282	315	355
355	500	710	355	400	447
			447	500	562
			562	630	708
710	1000	1420	708	800	891
			891	1000	1122
			1122	1250	1413

Octave			1/3-Octave		
Lower cutoff frequency (Hz)	Centre frequency (Hz)	Upper cutoff frequency (Hz)	Lower cutoff frequency (Hz)	Centre frequency (Hz)	Upper cutoff frequency (Hz)
1420	2000	2840	1413	1600	1778
			1778	2000	2239
			2239	2500	2818
2840	4000	5680	2818	3150	3548
			3548	4000	4467
			4467	5000	5623
5680	8000	11360	5623	6300	7079
			7079	8000	8913
			8913	10000	11220
11360	16000	22720	11220	12220	14130
			14130	16000	17780
			17780	20000	22390

Memory results

The CEL-63x instrument has 1 GB of memory that is available to store the results of the instrument's measurements.

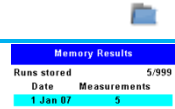

The Results memory stores all measurements made when the CEL-63x instrument operates in the measurement run mode.

The first screen shows the dates of the runs stored, and how many runs are stored for each date. You can select any date in the list to view a list of the runs stored for the selected date.



The daily results screen shows a list of results, identified by their Run ID numbers, stored from a single day of measurements. Each entry in the list shows the time when the run started, and the run's duration.



The screen always lists the runs with the newest at the top.

You can select one of the runs to see the summary and the details for that run. A series of screens shows information about the run's measurements. A graph icon shows that the run includes a profile time history. Refer to [Data sets](#) on page 36 for an explanation of the periodic time history.

View results

The View results screens allow you to see the results of measurement runs that are stored in the CEL-63x instrument's memory.

There are three options available when you view the Memory results:

- [View results](#)
- [Delete](#)
- [Printing](#) – Only available when printer -CMC73 is connected.

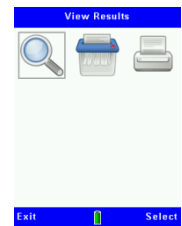

IMPORTANT

Note that the functions displayed on the View results screens are those that you define in the current measurement setup. You can use the View results screens to review any measurement function.

Delete

The Delete screen allows you to delete a single run after you select it, or you can delete all runs stored in the instrument.

You can confirm or cancel the command to delete the runs, but you cannot restore a run after you delete it.

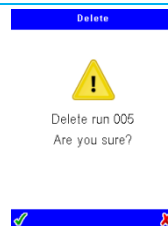

Printing

The CEL-63x has two different methods of printing measurement results using a 3-inch thermal printer (-CMC73). **Print Report** prints a measurement run report, and **Print Screen** prints a copy of any of the result screens. Both options print in the currently selected language.



NOTE

If you are using the printer for the first time with the CEL-63x, refer to [“Printer set-up”](#) on page 42 before you start.

While the printer (-CMC73) is connected to the CEL-63x instrument and is switched on then a Printer icon is displayed on the **Memory results** screen. Select this Printer icon to display the **Print Report** options for the current run and to print the report, or follow the instructions in [“Print Screens”](#) on page 42 to print some screens.

Print Report

Select the Printer icon to display the **Print Report Options** screen.

This screen has the following options:

- **Own Logo** – This option prints a stored user logo before the report (see later for details).
- **Octave Leq + Max** – If narrowband results are stored this gives the option to print the L_{eq} and Max for each octave or 1/3-octave band.
- **Octave Ln’s** – If narrowband Ln’s are stored and some Ln’s are currently selected this gives the option to print those Ln values for each octave or 1/3-octave band.
- **Period 0010 – 0020 / 0075** – If the run stores two or more period results then the user can select to print the results for up to 25 periods at a time. In this example periods 10 to 20 are printed from the set of 75 period results stored.
- **Print Report** – When this option is selected, pressing the **Print** key prints the report. Pressing **Exit** or switching the printer off stops any current printing.

The printed report includes the optional user logo; the run start date and time and duration; and the instrument setup and calibration data. This is followed by the cumulative or period broadband and narrowband results and then by the Location, Operator and Signature fields which can be filled in by the user.

**NOTE**

The functions printed in the report (and displayed on the results screens) are those that are defined in the current measurement setup. The printing of octave and 1/3-octave results can use considerable amounts of printer paper, especially if a number of different periods are printed.

Up to five functions are printed for each set of frequency bands, so if Octave Leq + Max is enabled then selecting more than three Ln functions in the current measurement setup will require two sets of frequency bands to be printed, using more paper. Disabling both Octave options above just prints a broadband set of results.

Print Screens

This mode captures the current result screen and prints a graphical copy of this screen to the printer.

While displaying the Memory results screen, select the View icon (instead of the Printer icon) and use the keys to select each screen of the current runs results. Press the **Run/Stop** key when you want to print the current screen.

This printing format is particularly useful when displaying octave or 1/3-octave results when the graphical bar graph of the spectrum can be printed for any of the selected narrow band functions.

Any mix of print reports and result screens can be printed.

Printer set-up

It is necessary to set up the printer (-CMC73) before using it for the first time.

**NOTE**

Refer to the User and Programming manuals for the -CMC73 on the CD which is supplied with the printer for details on setting the dip switches and the RS232 protocol.

The -CMC73 printer dip switches SW1, SW2, SW3 and SW4 should ALL be in the OFF position, which selects the following options:

- wide paper roll (78 mm)
- ESC/POS mode
- Hardware handshaking
- Normal operation

The -CMC73 uses the following RS232 settings when used with a CEL-63x:

- 115200 baud
-

- 8 data
- 2 stop bits
- no parity.

This printer should be loaded with 78 mm thermal paper and connected to the CEL-63x using Casella CEL cable (Casella CEL part number 196137B) which connects to the RS232 cable supplied with the printer.

If the printer does not print anything sensible, then perform a test print and ensure the above RS232 protocol is selected (see the -CMC73 User Manual for details).



NOTE

If it is required to print Chinese reports then the printer must be loaded with the GB2132 Chinese character set. Contact the printer supplier or Casella CEL for details.

Adding your own Logo to print reports

It is possible to add your own logo to personalise reports. These can be any size up to 127 dots wide × 248 dots high. This feature can be used to add a company logo or to have extra fixed text or symbols. For example, if you wanted to add details of the weather then a box titled Weather could be printed with the report and the user could then write in the weather by hand.

The logo is downloaded and kept in the printer flash memory using the LOGO MANAGER IBM PC software which is on the CD disc supplied with the printer. If the **Own Logo** option is enabled in the print report options then this logo will be automatically printed at the start of the report.

Instrument status

Select the Status option in Menu mode to see information about the instrument's status. This is the same screen that the instrument shows after you switch the instrument ON.

Refer to [Status](#) on page 26 for a description of the Status screen.



USB connect mode

The CEL-63x instrument has a mini USB port that allows you to connect the instrument to a PC running Windows® XP or Windows® Vista or Windows® 7.

When the instrument detects that it is connected to a PC, the instrument displays an option to stop any run that is currently active. The instrument then switches to Active USB mode. You should use the Insight program supplied by Casella to download results to the PC. See "[Mini B](#)



[USB port](#)” on page 52 for information about the connection to make for this purpose.

The PC recognises the instrument as a removable drive, and identifies it by an available drive letter, for example J:.



IMPORTANT

The CEL-63x instrument stores measurements as binary files. You must use the optional Insight software, supplied by Casella CEL, to read these files.



CAUTION

Always use the Safely Remove Hardware icon in the Notification Area of the PC's taskbar to disconnect the CEL-63x.

4.4 Measurement views

User settings

The CEL-63x instrument has two measurement views that are available for user-defined settings. These measurement views are called User 1 and User 2. Refer to “[User-defined measurement view](#)” on page 17 for instructions to use these settings.

When you select one of the user-defined views, you can change the following settings:

- [Microphone response](#)
- [L_{Avg} threshold](#)
- [Octave weighting](#)
- [Octave time constant](#)
- [Measurement functions](#)

Microphone response

The setting options are for a **Random** or for a **Free field** microphone response.

True random field and free-field conditions do not exist in normal environments. The response patterns measured are close approximations to the theoretical measurements under the defined conditions.

Random field

A random-field microphone response is often necessary to conform to US regulations.

A random-field response is where sound energy is distributed uniformly throughout the space being measured.

Free field

A free-field microphone response is generally necessary to conform to regulations throughout the European Union.

A free-field response is where sound propagates directly from a source to a microphone without any form of obstruction.

L_{Avg} threshold

The L_{Avg} threshold can be set in the range 0 dB or 70 dB to 90 dB.

This threshold is used in the calculation of the average sound level (L_{Avg}) over the measurement period (equivalent to L_{eq}). L_{Avg} is a function used in OSHA measurements.

Normally, the term L_{Avg} is used when the exchange rate Q is some value other than 3, for example when making measurements for the OSHA Hearing Conservation Amendment with $Q = 5$. The threshold value is used during calculation of L_{Avg} , where any levels below the threshold are not included.

Example:

Assume the threshold level is set to 80 dB and the exchange rate is 5 dB ($Q = 5$). In this case, if you made a one-hour measurement in an environment where the noise levels varied between 50 dB and 70 dB, the sound level would never exceed the threshold so the instrument would record no value for the L_{Avg} .

However, if the sound level exceeds the 80 dB threshold for only a few seconds, only these seconds contribute to the L_{Avg} , producing a result of approximately 40 dB. This result is much lower than the actual ambient sound levels in the measured environment.

Octave weighting

The setting options are for **A**, **C** or **Z** weighting

This is the octave weighting used to display octave or $\frac{1}{3}$ -octave band results.

- **A weighting** is the usual method of adjusting the measured sound pressure level so that the measurements represent the frequency response of the human ear.
- **C weighting** applies only a relatively small correction to very high and low frequencies. C weighting represents how the human ear responds at very high noise levels.
- **Z weighting** does not include any frequency correction to the sound pressure levels, so that the response is effectively 'flat'.



NOTE

Whichever setting you use for octave weighting, the CEL-63x instrument only stores Z-weighted measurements. This allows you to transfer measurements to a PC for post-processing to A or C weighting using the Casella 'Insight' software.

Refer to "[Mini B USB port](#)" on page 52 for information about connecting the instrument to a PC.

Octave time constant

The setting options are for **F** (Fast) or **S** (Slow) octave time constant.

This setting defines the time weighting used to display octave or $\frac{1}{3}$ -octave band results, and how quickly the CEL-63x instrument responds to changes in sound pressure level.

Most measurements are made using the Fast octave time constant. When using this setting, the instrument applies a $\frac{1}{8}$ -second (125 ms) time constant to the sound pressure level.

Fast measurements are identified by using the subscript 'F', for example L_{AF} shows the sound pressure level using A weighting and the Fast octave time constant.

When you set the instrument to use the Slow octave time constant, it applies a 1-second time constant to the sound pressure level.

Slow measurements are identified by using the subscript 'S', for example L_{AS} .

Measurement functions

You can select up to nine measurement functions for each user-defined measurement view. The bottom of the screen has a counter to show how many functions you have selected, for example "7/9".

Figure 12. User-defined measurement view

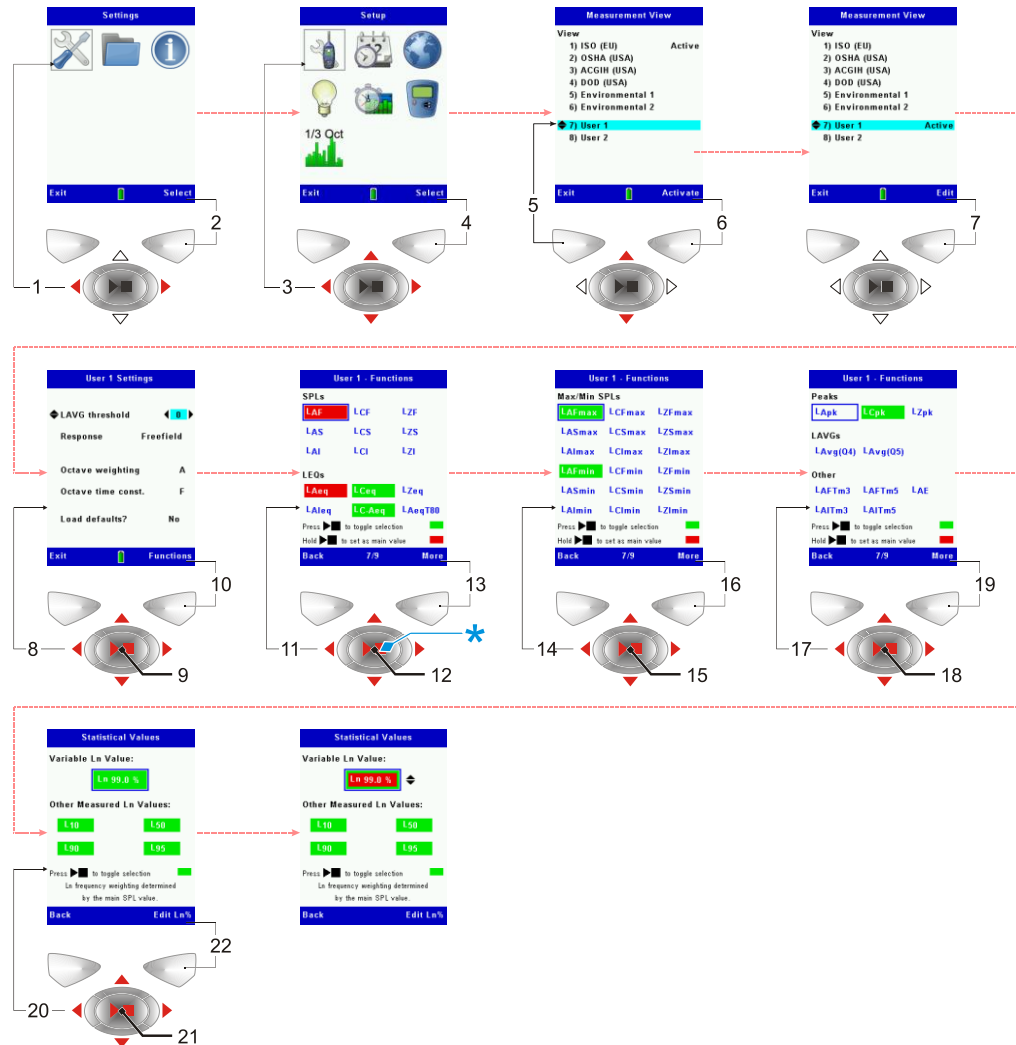

The CEL-63x instrument has four screens that show the functions available for selection.

1. The [first screen](#) shows Sound Pressure Levels (SPLs) and Equivalent Continuous Sound Pressure Levels (L_{eqS}).
2. The [second screen](#) shows Maximum and Minimum SPLs.
3. The [third screen](#) shows Peaks, averages (L_{AVG} s) and other functions.
4. The [fourth screen](#) shows Statistical Values (L_n).

SPL and L_{eq}

SPL

The function highlighted in red is the main SPL (instantaneous sound pressure level) that is currently selected. This is the SPL value shown on the screens when the instrument is in [Measurement stop](#) or in [Measurement run](#) mode.

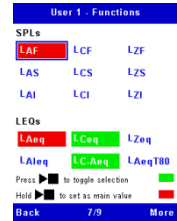

The functions highlighted in green are the other functions that are selected for display during a measurement run.

You can select other SPL functions by using the Navigation keys and then press the **Run/Stop** key to add the selected function to the user-defined measurement view.

You can select an SPL function and hold the **Run/Stop** key pressed for one second to set the selected function as the main SPL.

You can also select any non-SPL function. Keep the **Run/Stop** key pressed for one second to set the selected function as the main run function. This will then be displayed using a larger font during a run.

The CEL-63x instrument allows you to store statistical information, L_n , about the instrument's measurements. The recorded L_n values include A, C and Z weightings. Refer to [Statistical](#) on page 51 for an explanation of the statistical functions. The L_n values are ALWAYS calculated using the Fast octave time constant.

L_{eq}

L_{eq} is the equivalent continuous sound pressure level. It is an average of the total sound energy measured over a specified period of time. It represents the level of a steady, continuous noise that has the same total energy as the real varying noise measured over the same period.

The functions highlighted in green are the other functions that are selected for display during a measurement run.

The L_{eq} subscript identifies the frequency weighting used when calculating the L_{eq} function, for example L_{Ceq} is the C-weighted L_{eq} .

Other functions listed under L_{eq} are as follows:

- L_{Aeq} is an integrating A-weighted measurement of impulse L_{eq} . Integrated measurements provide an L_{eq} measurement that assesses exposure to noise levels, and are used in the calculation of the personal noise exposure L_{EP} as defined by ISO 1999.
- $L_C - L_A$ is a measurement that is used in the HML method, where separate values for high, medium and low frequencies provide a better estimate.
- L_{AeqT80} is an A-weighted measurement of L_{eq} that has a threshold setting of 80 dB. This is used for ACGIH in the USA only.

Maximum and Minimum SPLs

This screen allows you to select among the available maximum and minimum SPL functions.

The subscripted letters identify the frequency weighting and the time constant to be used for the measurement, and whether the measurement is a maximum or a minimum.

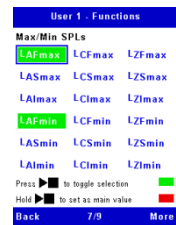

Peaks, L_{Avg} and other functions

Peaks

The Peaks functions are L_{APk} , L_{CPk} and L_{ZPk} .

These functions record the peak levels of noise using A, C and Z weighting.

L_{Avg}

L_{Avg} is the time-averaged noise level with an applied exchange rate, measured during the run. The two options are to use exchange rates Q5 (5 dB) or Q4 (4 dB).



Other functions

- L_{AE} is the A-weighted exposure level (previously known as SEL). It is the sound pressure level that would contain the same amount of energy in one second that the actual noise has during the whole measurement period.
- L_{Tm3} and L_{Tm5} functions are Taktmaximal A-weighted fast or impulse measurements.

Taktmaximal measurements are specified in German noise standards (the DIN standard). They integrate noise over a 3 second or a 5 second

period and produce an average level that assumes the highest level was present for the entire 3 or 5 second period.

Statistical values

The statistical functions L_{10} , L_{50} , L_{90} and L_{95} show the sound pressure levels that are exceeded for 10 %, 50 %, 90 % and 95 % of the measurement period respectively. For example, the measurement L_{10} is the level exceeded for 10 % of the measurement time and L_{90} is the level exceeded for 90 % of the measurement time.

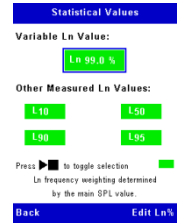

The CEL-63x instrument also provides a user-defined, variable statistical measurement.

4.5 Connections

All connections to the CEL-63x instrument are made through three ports behind a hinged panel at the bottom of the instrument.

Figure 13. Connection ports



1. [Power input port](#)
2. [Mini B USB port](#)
3. [AC and DC output port](#)

Power input port

The power input port allows you to connect a DC power supply to operate the instrument.

You must use a 2.1 mm DC plug that has the positive supply connected to the centre receptacle.



CAUTION

You must make certain the DC power input ground is kept isolated from any signal ground.

Refer to "[Mains DC supply](#)" on page 10 for information about the requirements of a suitable mains DC power supply for use with the CEL-63x instrument.

Mini B USB port

The mini B USB port allows you to connect the CEL-63x instrument to PC.

When you connect the instrument to a PC, the instrument appears as a removable disk drive in Windows Explorer.

The **Casella Insight** data management software is available from Casella CEL. You must use this program to download measurements directly from the instrument without using Windows Explorer. The Insight software includes

analysis and graphing tools, which you can use to analyse and view measurement runs.

Contact Casella CEL for more information about the Insight program.

AC and DC output port

The AC and DC output port is a 2.5 mm stereo jack. It has two functions:

- The tip connection (1) provides an AC output from the instrument. You can use this output for remote monitoring, and for providing a signal to a separate recoding device or headphone amplifier.

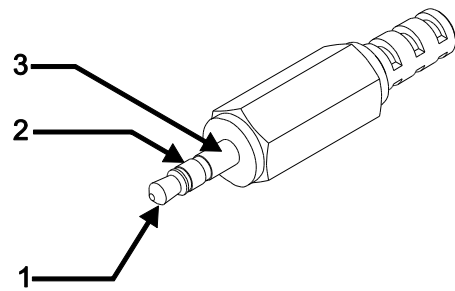

The AC output level is approximately 0.4 V_{rms} full scale, which corresponds to a sound pressure level of 96 dB with AC Low Output selected (refer to the note on page 25 for more information). The output impedance is approximately 2.2 k Ω . The AC output corresponds to the Z-weighted response of the instrument.

If you use the AC output, you should make certain the load impedance is as high as possible, and you should use a co-axial cable of length 0.5 m to 10 m.

- The ring connection (2) provides a DC output voltage that is proportional to the measured sound pressure level. The DC output voltage is scaled linearly at 0.01 V/dB with a maximum value of 1.4 V DC, which represents 140 dB.

The output impedance is approximately 2.2 k Ω . The DC output corresponds to the A-weighted fast time response of the instrument.

If you use the DC output, you should make certain the load impedance is as high as possible.

The signal ground for the AC output and for the DC output is on the barrel connection (3). The signal ground must be isolated from the ground connection of the DC power input when you use a mains DC supply.

High-level noise measurements

The CEL-63x instrument may be used to measure sound pressure levels up to 165 dB when used in conjunction with microphone CEL-259/A. To set the

instrument to the 140 dB or the 165 dB full-scale measurement mode, refer to the System Tools menu (see the note on page 25).

5 Specifications

5.1 General

The CEL-63x family is a range of instruments that support different firmware functionality. Figure 14 below shows the functionality of the models in the range.

Figure 14. CEL-63x instrument functionality

Application	Model number	Store cumulative data	Data markers	Run duration timers	Logging of Time History	Automatic On/Off timers	Statistical parameters (Ln%)
Occupational	CEL-630	✓	✓	✓			
Environmental	CEL-631	✓	✓	✓			✓
Occupational (with logging)	CEL-632	✓	✓	✓	✓	✓	
Environmental (with logging)	CEL-633	✓	✓	✓	✓	✓	✓

5.2 Standards

The CEL-63x instrument provides SPL, Integrating and Octave band noise measurements compliant with the following international standards:

- IEC 61672-1: 2002-5 (Electro-Acoustics – Sound Level Meters) Group ‘X’ instruments. Performance of Class 1 or 2 as relevant to the instrument model.
- IEC 60651: 1979, IEC 60804: 2000, ANSI S1.4 1983, ANSI S1.43-1997(R2007)
- 1/1 Octave and 1/3 Octave Filters comply with EN61260: 1996, Class 0 and ANSI S1.11 1986, Order-3 Type 0C.

5.3 Measurement range

Single measurement range up to 140.2 dB(A) RMS and 143.3 dB(C) peak.

Linearity range from 10 dB above noise floor.

5.4 RMS frequency weightings

A, C and Z filter weightings satisfying IEC 61672-1: 2002 Class 1.

5.5 Octave and 1/3-Octave measurement

Octave: Real-time 11 bands with centre frequencies from 16 Hz to 16 kHz.

1/3-Octave: Real-time 33 bands with centre frequencies from 12.5 Hz to 20 kHz.

The displayed spectrum can be pre-weighted with A, C or Z.

Z-weighted octaves are stored only to be post-weighted in Insight software.

5.6 Peak measurement

A-, C- or Z-weighted from 65.0 dB to 143.3 dB.

5.7 RMS detector

Digitally-derived true root-mean-square (RMS) detection, 0.1 dB display resolution.

5.8 Noise floor

Total inherent noise including microphone thermal noise at 20 °C:

- <20 dB (A) Class 1
- <24 dB (A) Class 2

Electrical noise floor <17.5 dB (A).

5.9 Frequency response

6 Hz to 20 kHz (lower and upper 3 dB frequencies).

Digital sampling rate 67.2 kHz.

Overall Class 1 and Class 2 frequency response compliant with IEC 61672-1: 2002

5.10 Time weightings

Fast (F), Slow (S) and Impulse (I) according to IEC 61672-1: 2002.

5.11 Correction filters

Built-in correction filter for random incidence sound pressure fields.

5.12 Reference direction

For free-field measurements the reference direction is perpendicular to the microphone diaphragm.

5.13 Reference conditions

- 23 °C air temperature
- 50 % relative humidity (RH)
- 101.325 kPa atmospheric pressure
- Nominal reference level = 114.0 dB at 1 kHz

5.14 Operating environmental conditions

Humidity	5 % to 90 % RH non-condensing
Temperature	-10 °C to +50 °C (Class 1) 0 °C to +40 °C (Class 2)
Pressure	65 kPa to 108 kPa

5.15 Effects of temperature

Electrical stability of the instrument $< \pm 0.2$ dB over the range -10 °C to +50 °C

5.16 Effects of humidity

Less than ± 0.5 dB over the range 25 % to 90 % RH (non-condensing) relative to the value under reference conditions.

5.17 Storage environmental conditions

Humidity	0 % to 90 % RH non-condensing
Temperature	-20 °C to +60 °C
Pressure	65 kPa to 108 kPa

5.18 Microphones

CEL-251 1/2-inch Class 1, 50 mV/Pa pre-polarised back electret

CEL-252 1/2-inch Class 2, 30 mV/Pa pre-polarised back electret

Microphones use a separate pre-amplifier CEL-495.

-MIC1 High-range 1/4-inch high-range microphone, 2.8 mV/Pa pre-polarised back electret

-MPA1 1/2-inch to 1/4-inch adaptor

5.19 Calibration

Auto-calibration by application of a 1 kHz calibrator tone, nominal level 114 dB or 94 dB ± 1 dB.

Auto-calibrated to a user-specified reference level with recording of date, time and offset.

5.20 Power supply

External DC Optional -PC18 12 V DC universal power supply adaptor available from Casella CEL.

- Supply voltage 12 V DC
- Supply current 170 mA continuous rating
- 2.1 mm power connector

Batteries Three AA alkaline or rechargeable cells.

Battery life Typically better than 8 hours in broadband mode with backlight continuously on at low intensity. High levels of backlight intensity reduce the battery life.
Typically 12 hours measurement time with backlight OFF.

5.21 Internal clock

Date and time accuracy better than ± 2 seconds per day.

5.22 Languages

English (default)	English (US) (date/time format)	Spanish
French	German Italian	Portuguese
Chinese	Brazilian Portuguese	

5.23 Electromagnetic compatibility

The instrument is designed and tested to comply with the following EMC and ESD standards:

- IEC 61000-4-2 Testing and Measuring Techniques – Electrostatic discharge immunity tests.
- IEC 61000-6-2 Generic standards – Immunity for industrial environments.

5.24 Effects of AC power frequency fields

Less than ± 0.5 dB change from 74 dBA 925 Hz reference level when subjected to 160 A/m AC magnetic field at 50 Hz and 60 Hz.

5.25 Tripod mounting

Socket to mount on standard 1/4-inch (Whitworth) camera tripod thread.

5.26 Display

320 × 240 pixels transmissive colour TFT, update period 0.5 seconds.

5.27 Memory

Micro SD 1 GB non-volatile internal memory.

Maximum capacity: Limited to either:
1. 999 individual runs, or
2. 400 separate runs of 24 hours duration with 1 minute periods and 1 second profiles.

5.28 Connectivity

Refer to Figure 13.

USB Mini B (-CMC51) to download to Casella Insight data management software.

AC output 2.5 mm stereo jack (barrel ground, tip AC output) provided for remote monitoring or recording, PC WAV file recording or headphone applications.

Approximately 0.4 Vrms full-scale output corresponding to 96 dB. Output impedance is approximately 2.2 k Ω . Load impedance should be as high as possible, and a coaxial connection cable of between 0.5 metres and 10 metres length should be used.

	The AC output corresponds to the Z-weighted response of the instrument.
DC output	<p>2.5 mm stereo jack (barrel ground, ring DC output) provided for chart recorders, loggers and so on. Some offset and scaling is necessary on the measuring system for accurate measurements.</p> <p>Approximately 1.4 V DC full-scale output corresponding to 140 dB. Output impedance is approximately 2.2 kΩ. Load impedance should be as high as possible.</p> <p>The DC output corresponds to the A-weighted, fast time response of the instrument.</p> <p>Note that the DC power input ground must be kept isolated from any signal ground.</p>

5.29 Available data sets

A) Broadband Cumulative and Periodic Results

For each complete measurement run the instrument stores the following:

- Run start Date and Time
- Run duration
- Run overload time
- Run pause times
- Run Id
- Instrument serial number
- Current measurement setup data
- The Last calibration before run started results
- The First calibration after end of run results
- The Overload and Battery fail flags
- The Environmental indices LDN, LDEN, CNEL

In periodic mode the following set of results is produced for each of the period intervals during a run.

In cumulative mode the following single set of results is produced covering the whole run.

- Sound pressure levels (SPL)
 - L_{AF}
 - L_{CF}
 - L_{ZF}
 - L_{AS}
 - L_{CS}
 - L_{ZS}
 - L_{AI}
 - L_{CI}
 - L_{ZI}

Note that the SPLs are displayed but are NOT stored.

- Equivalent continuous sound pressure levels (L_{eq})
 - L_{Aeq}
 - L_{Ceq}
 - L_{Zeq}
 - L_{A1eq}
 - $L_C - L_A$
 - L_{AeqT80}
- Maximum and minimum sound pressure levels

○ L_{AFmax}	L_{AFmin}
○ L_{CFmax}	L_{CFmin}
○ L_{ZFmax}	L_{ZFmin}
○ L_{ASmax}	L_{ASmin}
○ L_{CSmax}	L_{CSmin}
○ L_{ZSmax}	L_{ZSmin}
○ L_{AImax}	L_{AImin}
○ L_{CImax}	L_{CImin}
○ L_{ZImax}	L_{ZImin}
- Maximum and Minimum times
The time for each of the 18 maximum and minimum sound pressure levels is stored to 1 second resolution
- Peak sound pressure level
 - L_{Apk}
 - L_{Cpk}
 - L_{Zpk}
- Peak times
The time for each of the three peak levels is stored to 1 second resolution

- Average sound pressure level with exchange rate Q
 - $L_{Avg(Q4)}$
 - $L_{Avg(Q5)}$
 each with threshold 0 dB or 70 to 90 dB

- Other measurements
 - $L_{AF(Tm3)}$
 - $L_{AF(Tm5)}$
 - $L_{AI(Tm3)}$
 - $L_{AI(Tm5)}$
 - L_{AE}

- Statistical parameters (L_n)
 - L_{AF10} , L_{AF50} , L_{AF90} , L_{AF95} , $L_{AFvariable}$
 - L_{CF10} , L_{CF50} , L_{CF90} , L_{CF95} , $L_{CFvariable}$
 - L_{ZF10} , L_{ZF50} , L_{ZF90} , L_{ZF95} , $L_{ZFvariable}$

- Other Data
 - Start period time
 - Period duration
 - Period overload time
 - Period Pause and Back erase time
 - Period Overload and Battery fail flags

B) Octave and 1/3-Octave Cumulative and Periodic results

In addition to all the broadband results listed above, the instrument can also produce the following results for each of the octave or 1/3-octave bands:

- L_{Zeq} , L_{ZFmax} , L_{ZSMmax} , L_{ZF10} , L_{ZF50} , L_{ZF90} , L_{ZF95} , $L_{ZFvariable}$
- L_{Ceq} , L_{CFmax} , L_{CSMmax} , L_{CF10} , L_{CF50} , L_{CF90} , L_{CF95} , $L_{CFvariable}$
- L_{Aeq} , L_{AFmax} , L_{ASMmax} , L_{AF10} , L_{AF50} , L_{AF90} , L_{AF95} , $L_{AFvariable}$

Only L_{ZF} are stored. The Casella Insight data management software allows calculations for L_A and L_C .

C) Profile Results

For each profile interval the following results are produced:

- Broadband L_{Aeq} , L_{AIeq} , L_{AFmax} , L_{ASmax} , L_{AImax} , L_{CPEAK}
- Profile start time
- Overload and battery fail flags

D) Marker Event Results

This produces a file of events where each event is either one of four markers or a Pause or a back-erase event. The Start time, duration and type of event is stored for every event during each measurement run.

Insight can show these events on graphs of the measurement results.



The above results can be viewed on the instrument or by using Insight, and different results can be viewed even after the run has finished by changing the measurement view.

The following settings CANNOT be changed after the run has completed. Therefore it is important to set them correctly BEFORE you start the measurement run:

1. Microphone response (random or free-field)
 2. L_{Avg} threshold
 3. L_n variable percentile
-

Measurement run duration

In manual Cumulative mode a run will end automatically after 24 hours.

In manual Periodic mode a run will end at midnight and a new run will start again automatically immediately to produce a set of results for each day. This sequence can continue for up to 400 days if the instrument is left running indefinitely.

When using the Delay or Timer measurement controls, the cumulative or periodic run will continue for up to 24 hours under control of the delay or timers.

5.30 Physical

Dimensions	71.5 mm wide 230.0 mm high 31.0 mm deep (Dimensions include microphone and removable pre-amplifier CEL-495)
Weight	0.332 kg with batteries 0.254 kg without batteries

6 Care and maintenance

- Use a clean, slightly damp cloth to wipe the outside of the CEL-63x instrument. Do not use abrasive, caustic or solvent materials to clean the instrument.
- Check the condition of the battery compartment when you fit batteries to the instrument. Check for signs of corrosion and arrange any repairs necessary.
- Remove the batteries from the instrument if it will not be used for a long period of time (more than one month).
- Do not allow the instrument to become wet, or to be exposed to extreme levels of dust, heat or cold.

7 Servicing and Warranty arrangements

7.1 Inspection and test

To make certain the CEL-63x instrument conforms to its published specification, the instrument is tested thoroughly and its accuracy is verified before shipment from the factory. All technical information about each individual instrument is filed under the instrument's serial number, which you should include in any correspondence concerning this instrument.

7.2 Lifetime Warranty Terms and Conditions

This warranty provided by the manufacturer does not adversely affect the statutory rights of the purchaser against the seller and gives remedies in addition to those against the seller under the contract of sale.

Casella CEL warrants for the products stated below of their manufacture:

1. 24 months, from the date of invoice to the original purchaser.
2. Thereafter for the production lifetime of the product subject to regular calibration as detailed below.

Casella CEL undertakes that each new product supplied thereon by Casella CEL as original equipment will be free from defect in material or workmanship according to the state of the art under normal use and service for the production lifetime of the product. The warranty is valid for the original purchaser of the product.

Products covered by the Casella CEL Lifetime Warranty are: CEL-24X Series Sound Level Meters, CEL-35X Series dBadge Noise Dosimeters, CEL-6XX Series Sound Level Meters, TUFF Personal Air Sampling Pumps. Note: 'X' denotes the product variant. Includes Intrinsically Safe models where available.

The warranty applies to free of charge repair of the product by Casella CEL.

Casella CEL at its discretion may elect to agree with the owner a value for part exchange of the product in case the parts and labour cost of the repair exceeds the economic value of the product.

The Lifetime Warranty is valid for the following components of the product:

- Printed circuit boards
- Cases
- Displays
- Interfaces/keypads
- Pump assemblies
- Internal sensors

The warranty excludes the following components of the product or aspects of damage:

- Batteries (except back-up batteries)
- Microphones
- Cables and accessories of the product
- Damage caused by battery acid leakage
- Severe pump contamination
- Damage caused either accidentally or maliciously

The warranty starts with the date of invoice by Casella CEL.

Regular calibration: in order to continue the warranty past the original 2 years the product must be returned to Casella CEL or an authorised service centre on a yearly basis for calibration. Failure to do this will invalidate the lifetime warranty. The product must be returned within 30 days of either the expiry of the 24 month initial warranty and/or the date of invoice of the last calibration.

Casella CEL is a brand name of IDEAL INDUSTRIES LIMITED, a company registered with company number 01824671 whose registered office is at Whitebrook Park, Lower Cookham Road, Maidenhead, Berkshire SL6 8XY t/a Casella CEL whose principal place of business is at Regent House, Wolseley Road, Kempston, Bedford MK42 7JY.

7.3 Repairs

The manufacturer undertakes to put right any defect in the instrument that is attributable to a fault in its design or assembly and which becomes apparent during the warranty period.

To take advantage of this warranty, the instrument must be returned, carriage paid, to the manufacturer's factory or accredited agent, where the necessary repairs will be performed.

To obtain repair under warranty, the instrument should be packed in its original packing or an equivalent and returned to Casella CEL's local agent, or in the case of UK domestic sales, to the Casella CEL Service Department at Bedford. Please include the following information:

- Instrument type(s)
 - Serial number(s)
 - Firmware version number(s)
 - Customer name and address
 - Contact name and telephone number
 - Details of any PC and software involved, including version number(s)
 - The reason for returning the equipment, with a detailed description of the fault and a list of any error messages that might have been displayed
-

**NOTE**

Any stored data should be downloaded before sending the unit for service, because it may be deleted during service. Also, any customer set-up should be noted, because these may be changed or reset during service.

The necessary adjustments or repairs will be performed and the instrument returned to you as soon as possible.

After the warranty has expired (except on approved accounts), service work is undertaken against quotations and all packing and transit costs are charged extra.

7.4 User servicing

There are no user-serviceable components inside the CEL-63x instrument.

DO NOT open the instrument to attempt repairs. You will cancel the warranty if you attempt to open the instrument for any reason.

If you suspect the instrument has developed a fault, contact your local Casella CEL agent to arrange for service and repair.

8 Glossary

The following list defines some of the acoustic terms that you can find in this User Manual. For additional information, contact Casella CEL or your local agent.

Acoustic calibrator An instrument that provides a reference noise source with a standard level and frequency. It is used to calibrate and check the performance of sound level meters and noise dosimeters.

decibel (dB) The standard unit for measuring sound level and noise exposure.

dB(A) A-weighted sound level in decibels.

A-weighted measurements are shown by using the subscript 'A'.

A standard weighting of audible frequencies designed to imitate the response of the human ear to noise.

dB(C) C-weighted sound level in decibels.

C-weighted measurements are shown by using the subscript 'C'.

C-weighting is a weighting used in the Control of Noise at Work Regulations, and applies only a relatively small correction to very loud noise sources.

dB(Z) Z-weighted sound level in decibels.

Z-weighting applies no weighting to the frequency of measurement. It is a raw measurement of sound level across the complete frequency range of the instrument.

Fast time weighting

A standard time weighting applied to measurements.

Most measurements are made using the Fast time weighting. When using this setting, the instrument applies a 1/8-second (125 ms) time constant when calculating the sound pressure level.

Fast measurements are identified by using the subscript 'F'.

Impulsive time weighting

A standard time weighting applied to measurements.

When using this setting, the instrument applies a 35 ms time constant to rising signals and a 1500 ms time constant to decaying signals when calculating a sound pressure level.

The Impulse Time Constant was traditionally used to display an impulsive type noise, allowing the maximum levels to be more easily seen on a changing display.

Impulsive measurements are identified by using the subscript 'I'.

L_{AE}
A-weighted exposure level

The level that would contain the same amount of energy in one second as the actual noise has during the whole measurement period.

L_{Aeq}
A-weighted equivalent continuous sound energy level
(also L_{Ceq} , L_{Zeq})

The A-weighted (*also* C-weighted, Z-weighted) steady level that would contain the same amount of noise energy as in the actual noise, effectively giving an average level over the measurement period.

Following the ISO procedures, doubling the energy results in a 3 dB change in the L_{eq} . This is denoted by the exchange rate $Q=3$.

Example

If the noise level in a factory were a constant 85 dB and the measurement period were 4 hours, the L_{Aeq} would be 85 dB(A).

The calculation of L_{Aeq} does not use a threshold as in the calculation of L_{Avg} , except for the L_{Aeq} (T80) function defined for the ACGIH standard.

L_{AF}
(also L_{AS} and L_{AI})

The A-weighted sound pressure level measured using fast time weighting (*also* with Slow and Impulse time weighting).

L_{ASmax} (also L_{AFmax} and L_{AImax})	<p>The maximum A-weighted sound level measured using slow time weighting (also with Fast and Impulse time weighting).</p>
L_{Avg} Average sound level	<p>The average sound level over the measurement period is a function used in OSHA measurements and is equivalent to L_{eq}.</p> <p>Normally this term is used when the exchange rate Q is some value other than 3, such as for measurements used for the OSHA Hearing Conservation Amendment with $Q=5$.</p> <p>Example</p> <p>A Threshold value is used during the calculation of L_{Avg}, where any levels below the threshold are not included. For example, assume the threshold level is set to 80 dB and the exchange rate is 5 dB ($Q = 5$). If a one hour measurement were taken in an environment where the noise levels vary between 50 dB and 70 dB, the sound level would never exceed the Threshold and the instrument would record no value for the L_{Avg}.</p> <p>However, if the sound level exceeds the 80 dB Threshold for only a few seconds, only these seconds contribute to the L_{Avg}, giving a level of approximately 40 dB, which is much lower than the actual ambient sound levels in the measured environment.</p>
L_{Cpk} (also L_{Cpk} , L_{Zpk})	<p>The peak C-weighted (also A-weighted or Z-weighted) sound level.</p>
Peak	<p>The maximum level in dB reached by the sound pressure at any instant during a measurement period. The CEL-63x instrument can measure the peak sound pressure using A, C or Z weighting.</p> <p>Peak is the true peak of the pressure wave, which you should not confuse with the highest sound pressure level (which is called L_{max}).</p>
Slow time weighting	<p>A standard time weighting applied to measurements.</p> <p>When using this setting, the instrument applies a 1 second time constant when calculating sound pressure levels.</p> <p>Slow measurements are identified by using the subscript 'S'.</p>

SPL	The sound pressure level. This is the basic physical measure of noise and is normally expressed in dB.
Threshold	The sound pressure level below which sound measurements are excluded from the calculation.

9 Additional information

The following additional information relates to testing under IEC 61672-1:2002 section 9.3

1. Reference sound pressure level

The reference sound pressure level can be selected to 94 dB or 114 dB.

2. Reference level range

The CEL-63x instrument has a single measurement range of 0 dB to 140 dB.

3. Microphone reference point

The microphone reference point is the centre of the microphone's diaphragm.

The 0° reference direction is perpendicular to the microphone's diaphragm.

4. Acoustical frequency response testing

Table 3 shows the pressure to free-field correction data for the CEL-251 microphone used for periodic testing.

Table 3. Pressure to 0° free-field corrections

Frequency	Without wind screen	With wind screen	Without wind screen	With wind screen	Expanded uncertainty of corrections at 95 % probability (k=2)
	Bruel & Kjeur 4226 calibrator		Bruel & Kjeur UA0033 electrostatic actuator		
Hz	dB	dB	dB	dB	dB
31.5	-0.1	-0.1	-0.1	-0.1	0.2
63	-0.2	-0.2	-0.2	-0.2	0.2
125	-0.2	-0.2	-0.2	-0.2	0.2
250	-0.2	-0.2	-0.2	-0.2	0.2
500	-0.2	-0.2	-0.2	-0.2	0.2
1000	0	0.1	0	0.1	0.2
2000	0.3	0.7	0.3	0.7	0.3
4000	0.7	1.4	0.8	1.5	0.3
8000	2.8	2.5	3.1	2.8	0.4
12500	5.3	4.1	6.2	5.0	0.6
16000	6.4	4.5	7.8	5.9	0.6

5. Linear operating range

Table 4 shows the lower and upper limits of the linear operating ranges for electrical input or when using a CEL-251 microphone.

You should add 10 dB to the lower limit shown in this table when using a CEL-252 microphone.

Table 4. Linear operating range

Weighting	31.5 Hz	1 kHz	4 kHz	8 kHz	12.5 kHz
A	30 to 100	30 to 140	30 to 141	30 to 138	30 to 134
C	32 to 137	32 to 140	32 to 139	32 to 136	32 to 132
Z	38 to 140	38 to 140	38 to 140	38 to 140	38 to 140
C Peak	65 to 140	65 to 143	65 to 142	65 to 139	65 to 135

6. Linearity measurements starting point

The starting point for measuring linearity errors is **114 dB**.

7. Electrical input

The input device to apply electrical signals to the pre-amplifier is a series 18 pF ± 5 % capacitor. You can use the CEL-516-2 line input adaptor for this purpose. The electrical self-generated noise can be measured with the supplied shorting plug attached to the CEL-516-2.

8. Self-generated noise

Self-generated noise is a combination of microphone thermal noise and the instrument's electrical noise. Table 5 shows the self-generated noise levels for a range of conditions.

Table 5. Self-generated noise using a type CEL-251 microphone

Weighting	Electrical Typical dB	Electrical Max dB	Microphone Thermal dB	Combined Typical dB	Combined Max dB
A	15.0	17.5	16.0	18.5	20.0
C	18.0	21.0	16.8	20.6	23.0
Z	24.0	26.5	16.8	25.0	27.0

Note that the CEL-252 microphone has a typical thermal noise level of 20 dB(A). When using the CEL-252 microphone, the combined typical and maximum noise levels will be 3 dB to 4 dB higher than the values shown in the table above.

9. Highest level

Using the microphones CEL-251 and CEL-252, the highest sound pressure level that the CEL-63x instrument has been designed to measure is 140 dB. These microphones have a nominal sensitivity of 50 mV/Pa.

The highest peak-to-peak voltage that can be applied safely to the pre-amplifier's input through the CEL-516-2 line input adaptor is 28.5 V.

For high-range instruments using the CEL-259 1/4-inch high-range microphone and CEL-259/A 1/2-inch to 1/4-inch adaptor, the highest sound pressure level that can be measured is 165 db.

10. Power supply voltage range

The CEL-63x instrument can be powered from three internally-fitted AA batteries, or from an external 12 V DC supply through a 2.1 mm connector (tip is positive). The instrument can also be powered from a 5 V DC supply through a USB connection to a PC.

- The DC supply range is 9 V to 14 V
- The USB supply range is 4.5 V to 5.5 V

When operating from internal AA batteries, the battery voltage range must be from 3 V to 5 V.

- A battery condition symbol on the instrument's screen flashes a warning when the battery voltage falls to 3.3 V or lower.
- The instrument stops the current run and turns OFF when the batteries have discharged to 3.0 V. This is to make certain the instrument does not make data measurements that will not meet the requirements of IEC 61672.

11. Display device

The display device displays the complete linear operating range.

12. Environmental stabilisation time

The typical time taken for the CEL-63x instrument to stabilise after sudden changes in the environmental conditions is as follows:

- 5 minutes after a 10 °C change in temperature
- 5 minutes after a 30 % change in humidity (non-condensing)
- 15 seconds after a 5 kPa change in ambient pressure

13. Electric field strength greater than 10 V/m

The CEL-63x instrument has not been tested for field strengths greater than 10 V/m.

14. EMC emissions

When tested, emissions from the CEL-63x instrument were no greater in one plane or in any mode of operation than another.

15. EMC susceptibility

The CEL-63x instrument has a slightly higher susceptibility with the Y direction facing the radiating antenna.

- X is the direction of the microphone
- Y is the direction to either side of the case
- Z is the direction perpendicular to the surface of the display



9.1 Sound calibrators – Level corrections

Sound level calibrators apply sound pressure to a microphone in a closed cavity. The microphone's response in a free field to a 1 kHz tone will be slightly different from that of a pressure field. Also, some calibrators are affected by the physical size of the microphone changing the volume of the calibrator's cavity.

The wind screen has an effect on the free-field response at 1 kHz. However, this can be compensated during calibration.

Table 6. Calibration corrections for the CEL-251 and CEL-252 microphones

Calibrator	Calibration Level Correction no Wind Screen	Calibration Level Correction with Wind Screen	IEC 60942
Casella CEL-110/1	-0.1dB	0.0dB	Type 1
Casella CEL-110/2	-0.1dB	0.0dB	Type 2
Bruel & Kjaer 4231	-0.1dB	0.0dB	Type 1 approved
Cirrus CR:515	-0.1dB	0.0dB	Type 1 approved

Examples

The CEL-63x instrument can be calibrated at a nominal level of 94 dB or 114 dB, depending on the type of calibrator used.

- If you use a CEL-110 or CEL-111 calibrator and the certified output from the calibrator is 113.98 dB, and you intend to use the instrument

without the wind screen, then you must set the calibration level to 113.88 dB. You must round this value to 113.9 dB.

- Calibrator level 113.98 dB
 - Correction -0.1 dB
 - Calibration level 113.88 dB rounded to 113.9 dB
- If you use a Cirrus CR:515 calibrator and the certified output from the calibrator is 94.04 dB, and you intend to use the instrument with the wind screen fitted, then you must set the calibration level to 94.04 dB. You must round this value to 94.0 dB.
 - Calibrator level 94.04 dB
 - Correction 0.0 dB
 - Calibration level 94.04 dB, rounded to 94.0 dB

Refer to section 3.4 “[Calibrating the instrument](#)” on page 12 for instructions to set the calibration level and calibrate the instrument.

9.2 Response characteristics

Table 7. Casella CEL-63X with CEL-251 Microphone Free Field response with and without Wind Screen

Nominal Frequency	Actual Frequency	0 Degree Free Field Response	0 Degree Free Field Corrections	Effect of Wind Screen	0 Degree Free Field Response with wind Screen	0 Degree Free Field Corrections with Wind Screen	Expanded uncertainty of Corrections (k=2)
Hz	Hz	dB	dB	dB	dB	dB	dB
250	251.19	0.0	0.0	0.0	0.0	0.0	0.16
315	316.23	-0.1	0.1	0.0	-0.1	0.1	0.16
400	398.11	0.1	-0.1	0.0	0.1	-0.1	0.16
500	501.19	0.1	-0.1	0.0	0.1	-0.1	0.16
630	630.96	0.0	0.0	0.1	0.1	-0.1	0.17
800	794.33	0.1	-0.1	0.1	0.2	-0.2	0.18
1000	1000.00	-0.1	0.1	0.1	0.0	0.0	0.19
1250	1258.92	0.0	0.0	0.2	0.2	-0.2	0.19
1600	1584.89	-0.4	0.4	0.3	-0.1	0.1	0.20
2000	1995.26	-0.2	0.2	0.4	0.2	-0.2	0.21
2240	2238.72	0.1	-0.1	0.4	0.5	-0.5	0.21
2500	2511.88	0.4	-0.4	0.5	0.9	-0.9	0.21
2800	2818.38	0.2	-0.2	0.5	0.7	-0.7	0.22
3150	3162.27	-0.3	0.3	0.6	0.3	-0.3	0.22
3550	3548.13	-0.9	0.9	0.7	-0.2	0.2	0.23
4000	3981.07	0.0	0.0	0.7	0.7	-0.7	0.23
4500	4466.83	0.0	0.0	0.7	0.7	-0.7	0.25
5000	5011.86	-0.1	0.1	0.6	0.5	-0.5	0.26
5600	5623.40	-0.4	0.4	0.5	0.1	-0.1	0.28
6300	6309.56	-0.7	0.7	0.2	-0.5	0.5	0.29
7100	7079.45	-0.1	0.1	-0.1	-0.2	0.2	0.32
8000	7943.27	-0.3	0.3	-0.3	-0.6	0.6	0.35
8500	8413.94	-0.4	0.4	-0.4	-0.8	0.8	0.38
9000	8912.49	-0.6	0.6	-0.5	-1.1	1.1	0.41
9500	9440.59	-0.8	0.8	-0.5	-1.3	1.3	0.44

CEL-63x Environmental Noise Meter

Nominal Frequency	Actual Frequency	0 Degree Free Field Response	0 Degree Free Field Corrections	Effect of Wind Screen	0 Degree Free Field Response with wind Screen	0 Degree Free Field Corrections with Wind Screen	Expanded uncertainty of Corrections (k=2)
Hz	Hz	dB	dB	dB	dB	dB	dB
10000	9999.98	-0.9	0.9	-0.7	-1.6	1.6	0.46
10600	10592.52	-0.8	0.8	-0.7	-1.5	1.5	0.48
11200	11220.16	-0.6	0.6	-0.9	-1.5	1.5	0.50
11800	11885.00	-1.0	1.0	-1.0	-2.0	2.0	0.52
12500	12589.23	-0.7	0.7	-1.2	-1.9	1.9	0.53
13200	13335.19	-1.0	1.0	-1.3	-2.3	2.3	0.55
14000	14125.35	-0.9	0.9	-1.4	-2.3	2.3	0.57
15000	14962.33	-1.0	1.0	-1.5	-2.5	2.5	0.59
16000	15848.90	-0.9	0.9	-1.9	-2.8	2.8	0.60
17000	16788.00	-1.0	1.0	-2.1	-3.1	3.1	0.60
18000	17782.76	-1.0	1.0	-2.4	-3.4	3.4	0.60
19000	18836.45	-1.0	1.0	-2.7	-3.7	3.7	0.60
20000	19952.58	-1.3	1.3	-2.6	-3.9	3.9	0.60

1. Corrections below 250Hz are 0.0dB

Table 8. CEL-63X with CEL-251 Microphone directional response (dB) relative to zero degrees (Orientation of CEL-63X - Display at 0 degrees relative to ground)

Nominal Frequency (Hz)	Actual Frequency (Hz)	0 Deg	10 Deg	20 Deg	30 Deg	40 Deg	50 Deg	60 Deg	70 Deg	80 Deg	90 Deg	100 Deg	110 Deg	120 Deg	130 Deg	140 Deg	150 Deg
500	501.19	0.00	0.01	0.01	0.00	-0.02	-0.05	-0.09	-0.20	-0.20	-0.26	-0.32	-0.35	-0.37	-0.36	-0.36	-0.34
630	630.96	0.00	0.02	0.04	0.05	0.06	0.06	0.05	-0.06	-0.06	-0.15	-0.25	-0.33	-0.38	-0.40	-0.41	-0.41
800	794.33	0.00	0.01	0.02	0.02	0.01	0.01	0.01	0.01	0.01	-0.04	-0.14	-0.29	-0.41	-0.45	-0.46	-0.42
1000	1000.00	0.00	0.01	0.03	0.03	0.04	0.05	0.06	0.02	0.02	0.01	-0.02	-0.14	-0.31	-0.38	-0.34	-0.29
1250	1258.92	0.00	0.02	0.03	0.01	-0.08	-0.21	-0.33	-0.15	-0.15	-0.05	-0.07	-0.15	-0.32	-0.59	-0.63	-0.51
1600	1584.89	0.00	0.00	0.00	-0.04	-0.09	-0.12	0.01	0.00	0.00	-0.07	0.20	0.18	0.03	-0.29	-0.61	-0.45
2000	1995.26	0.00	0.03	0.06	0.02	-0.20	-0.49	-0.36	-0.30	-0.30	-0.13	-0.25	-0.12	0.02	-0.19	-0.69	-0.98
2240	2238.72	0.00	-0.01	-0.12	-0.35	-0.50	-0.40	-0.56	-0.46	-0.46	-0.63	-0.41	-0.64	-0.24	-0.45	-0.94	-1.28
2500	2511.88	0.00	-0.08	-0.35	-0.60	-0.55	-0.70	-1.09	-1.37	-1.37	-0.98	-1.05	-0.85	-0.86	-0.75	-1.08	-1.60
2800	2818.38	0.00	-0.03	-0.06	0.06	-0.01	-0.76	-0.93	-1.59	-1.59	-1.60	-0.92	-1.19	-1.29	-0.64	-0.91	-1.84
3150	3162.27	0.00	-0.07	-0.04	0.29	0.41	0.11	-0.07	-0.72	-0.72	-0.97	-1.26	-0.70	-0.73	-0.69	-0.46	-1.24
3550	3548.13	0.00	-0.02	0.06	0.58	0.95	0.50	0.87	-0.54	-0.54	-0.40	-0.38	-0.20	-0.48	-0.55	-0.22	-0.66
4000	3981.07	0.00	-0.10	-0.58	-1.00	-0.75	-0.96	-0.29	-1.17	-1.17	-1.84	-1.75	-1.67	-1.22	-1.86	-1.32	-1.90
4500	4466.83	0.00	0.12	0.26	-0.18	-0.57	-1.11	-0.76	-1.06	-1.06	-1.70	-2.28	-2.28	-1.23	-1.70	-1.44	-1.52
5000	5011.86	0.00	-0.12	-0.57	-0.28	-0.41	-0.83	-1.52	-1.00	-1.00	-1.77	-2.63	-2.54	-2.24	-1.69	-2.71	-2.05
5600	5623.40	0.00	-0.13	-0.10	-0.07	-0.39	-0.88	-1.05	-1.10	-1.10	-1.21	-2.21	-2.66	-2.52	-1.59	-2.57	-1.97
6300	6309.56	0.00	0.03	0.50	0.47	0.22	-0.09	-0.88	-1.62	-1.62	-1.27	-1.82	-2.42	-2.64	-2.36	-2.36	-2.59
7100	7079.45	0.00	0.04	0.07	-0.45	-1.21	-1.38	-1.33	-3.14	-3.14	-2.42	-3.01	-4.30	-4.12	-3.39	-2.70	-4.15
8000	7943.27	0.00	-0.10	-0.41	-0.55	-0.61	-1.36	-1.79	-2.97	-2.97	-3.78	-2.67	-4.08	-4.64	-3.96	-3.80	-4.48
8500	8413.94	0.00	0.19	-0.15	-0.40	-1.00	-1.13	-2.07	-2.69	-2.69	-4.11	-3.20	-3.82	-5.66	-4.53	-4.05	-4.45
9000	8912.49	0.00	-0.21	-0.18	-0.75	-1.03	-1.72	-1.96	-2.25	-2.25	-4.89	-3.90	-3.40	-6.09	-4.88	-4.44	-4.72
9500	9440.59	0.00	0.33	-0.21	-0.23	-0.58	-1.18	-2.38	-2.72	-2.72	-4.04	-4.07	-3.56	-6.49	-4.93	-4.45	-5.00
10000	9999.98	0.00	-0.32	-0.55	-0.90	-1.43	-2.00	-2.30	-3.20	-3.20	-3.74	-5.31	-4.73	-6.06	-6.30	-4.77	-4.87
10600	10592.52	0.00	-0.21	-0.05	-0.51	-0.86	-1.67	-2.42	-4.85	-4.85	-4.05	-5.98	-5.57	-5.96	-6.64	-5.33	-5.81
11200	11220.16	0.00	0.17	-0.38	-0.62	-1.24	-1.87	-2.57	-4.84	-4.84	-4.29	-6.15	-5.55	-6.62	-7.64	-5.84	-6.57
11800	11885.00	0.00	0.10	-0.45	-0.71	-1.39	-1.95	-2.83	-4.67	-4.67	-5.10	-5.99	-6.49	-6.43	-8.77	-6.67	-7.11
12500	12589.23	0.00	-0.01	-0.59	-1.03	-1.44	-2.32	-3.12	-4.75	-4.75	-6.33	-6.14	-7.87	-6.60	-9.13	-7.33	-7.62

Maximum expanded uncertainty of above data with 95% probability (k=2)

- 500 Hz to 1 kHz 0.3 dB
- >1 kHz to 4 kHz 0.5 dB
- >4 kHz to 8 kHz 1.0 dB
- >8 kHz to 12.5 kHz 1.5 dB

Table 9. CEL-63X with CEL-251 Microphone directional response (dB) relative to zero degrees (Orientation of CEL-63X - Display at 90 degrees relative to ground)

Nominal Frequency (Hz)	Actual Frequency (Hz)	0 Deg	10 Deg	20 Deg	30 Deg	40 Deg	50 Deg	60 Deg	70 Deg	80 Deg	90 Deg	100 Deg	110 Deg	120 Deg	130 Deg	140 Deg	150 Deg
500	501.19	0.00	0.00	0.00	0.00	-0.01	-0.03	-0.06	-0.11	-0.16	-0.21	-0.25	-0.27	-0.28	-0.28	-0.28	-0.27
630	630.96	0.00	0.00	0.02	0.04	0.06	0.07	0.06	0.02	-0.04	-0.12	-0.21	-0.28	-0.33	-0.34	-0.34	-0.34
800	794.33	0.00	0.00	0.00	0.00	0.00	0.01	0.02	0.04	0.05	0.02	-0.07	-0.20	-0.31	-0.35	-0.36	-0.33
1000	1000.00	0.00	0.01	0.01	0.02	0.03	0.04	0.05	0.04	0.03	0.04	0.04	-0.08	-0.26	-0.34	-0.30	-0.23
1250	1258.92	0.00	0.01	0.03	0.02	-0.07	-0.22	-0.34	-0.31	-0.15	-0.05	-0.03	-0.05	-0.24	-0.59	-0.65	-0.51
1600	1584.89	0.00	-0.01	-0.03	-0.09	-0.15	-0.15	0.02	0.16	0.01	-0.05	0.24	0.24	0.11	-0.25	-0.64	-0.47
2000	1995.26	0.00	-0.01	0.01	-0.05	-0.28	-0.50	-0.36	-0.20	-0.31	-0.07	-0.26	-0.09	0.15	-0.11	-0.73	-1.05
2240	2238.72	0.00	-0.07	-0.24	-0.49	-0.56	-0.36	-0.54	-0.87	-0.59	-0.54	-0.28	-0.54	-0.10	-0.27	-0.92	-1.35
2500	2511.88	0.00	-0.10	-0.30	-0.44	-0.42	-0.80	-1.12	-0.82	-1.25	-0.95	-0.79	-0.72	-0.75	-0.45	-1.02	-1.58
2800	2818.38	0.00	-0.02	0.01	0.14	-0.02	-0.76	-0.84	-1.22	-1.37	-1.78	-1.18	-0.94	-1.12	-0.34	-0.69	-1.88
3150	3162.27	0.00	0.07	0.26	0.57	0.41	0.02	-0.06	-1.16	-0.83	-0.68	-1.38	-0.80	-0.52	-0.26	-0.21	-1.36
3550	3548.13	0.00	-0.12	0.07	0.77	1.23	1.10	1.03	0.44	-0.53	-0.38	-0.31	-0.26	-0.45	-0.49	0.62	-0.59
4000	3981.07	0.00	-0.27	-0.82	-1.02	-0.98	-0.98	0.18	-0.16	-1.03	-1.78	-1.55	-1.66	-1.13	-1.64	-0.51	-1.49
4500	4466.83	0.00	0.14	0.10	-0.57	-0.96	-2.12	-1.25	-0.69	-1.10	-2.06	-2.95	-2.20	-2.33	-1.84	-1.34	-1.50
5000	5011.86	0.00	-0.22	-0.42	0.14	-0.03	-0.18	-2.12	-1.99	-0.54	-1.24	-2.52	-2.73	-2.35	-1.45	-2.52	-1.18
5600	5623.40	0.00	-0.14	-0.12	-0.60	-0.45	-0.69	-0.37	-2.01	-1.84	-0.68	-2.16	-2.45	-2.31	-2.50	-2.53	-0.85
6300	6309.56	0.00	0.30	0.96	0.94	0.22	-1.14	-1.36	-0.25	-1.95	-2.02	-1.50	-2.13	-3.21	-3.48	-2.99	-1.10
7100	7079.45	0.00	0.16	0.06	-0.99	-1.64	-1.27	-0.83	-2.04	-3.21	-2.66	-2.37	-4.39	-3.44	-2.61	-3.21	-4.29
8000	7943.27	0.00	-0.28	-0.34	-0.55	-0.47	-1.52	-1.83	-1.99	-2.41	-4.06	-3.14	-3.68	-5.20	-3.60	-4.02	-4.53
8500	8413.94	0.00	-0.08	-0.66	-0.73	-1.06	-1.11	-2.71	-2.49	-2.77	-4.26	-4.25	-3.27	-6.01	-4.69	-4.62	-5.45
9000	8912.49	0.00	0.01	0.15	-0.40	-0.93	-1.50	-1.36	-3.30	-2.57	-3.43	-4.29	-2.58	-5.63	-4.75	-4.34	-5.53
9500	9440.59	0.00	-0.12	-0.61	-0.98	-1.07	-1.95	-2.23	-3.69	-3.05	-3.79	-6.18	-3.46	-7.41	-4.96	-5.05	-5.91
10000	9999.98	0.00	-0.12	-0.03	-0.36	-1.42	-1.54	-2.70	-2.36	-3.47	-3.48	-4.85	-4.69	-6.53	-6.43	-5.02	-5.12
10600	10592.52	0.00	0.09	-0.66	-0.64	-0.95	-2.05	-2.18	-3.76	-5.49	-4.18	-5.30	-7.67	-4.94	-7.23	-5.49	-5.74
11200	11220.16	0.00	-0.16	-0.36	-1.00	-1.78	-2.14	-3.28	-3.76	-4.71	-4.82	-5.82	-7.95	-5.48	-8.29	-6.30	-6.97
11800	11885.00	0.00	-0.17	-0.40	-1.05	-1.36	-2.36	-3.06	-3.89	-4.67	-6.56	-6.05	-8.09	-5.45	-9.54	-6.80	-7.32
12500	12589.23	0.00	-0.34	-0.59	-1.05	-2.02	-2.69	-3.45	-4.72	-5.59	-7.47	-6.61	-8.44	-6.05	-10.78	-7.16	-8.12

Maximum expanded uncertainty of above data with 95% probability (k=2)

- 500 Hz to 1 kHz 0.3 dB
- >1 kHz to 4 kHz 0.5 dB
- >4 kHz to 8 kHz 1.0 dB
- >8 kHz to 12.5 kHz 1.5 dB